

Tools, Equipment,
& Materials
Product Catalog

Fillauer®

Tools, Equipment,
& Materials
Product Catalog

Fillauer®

Fillauer®



George Fillauer Sr.

1914

George Fillauer Sr., a German immigrant, opens the Red Cross Pharmacy in Chattanooga, Tennessee.



Top: Red Star Pharmacy with George Fillauer Sr. and sons George Jr. and Carlton

Bottom: Lawrence Porten and Carlton Fillauer fitting a patient

1920 – 1930s

Red Cross Pharmacy, now Red Star Pharmacy, expands its services and hires German “orthomeister” Lawrence Porten to provide orthotic and prosthetic devices for veterans returning from World War I.

George’s sons, George Jr. and Carlton, join the company. George Jr. becomes a pharmacist and Carlton an orthotist-prosthetist.



George Fillauer Jr. and Carlton Fillauer

1940s

Carlton Fillauer becomes the first staff prosthetist named to the National Research Committee on Prosthetic Devices before returning to Fillauer Drug & Surgical Supplies in 1949.



1950 – 1960s

Carlton Fillauer is among the first class of practitioners to be certified by the American Board for Certification in Orthotics and Prosthetics (ABC) and was a charter member of the American Academy of Orthotists and Prosthetists (AAOP). In 1955, George Sr. retires and George Jr. takes over as president.

Carlton also serves as president of ABC in 1957 – 1958 and president of AOPA in 1962 – 1963.

1972

Fillauer merges with pharmaceutical and surgical company Durr Drug. The merge provides Fillauer with expansion and sales growth in surgical and orthopedic supplies.

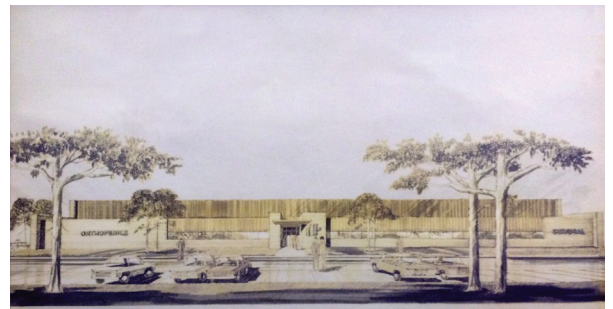

DURR-FILLAUER MEDICAL, INC.



1993

Bergan Brunswig Corp., now Cardinal Health, acquires Durr-Fillauer in a hostile takeover seeking its pharmaceutical and surgical supply divisions. Karl Fillauer and a group of investors purchase the orthotic and prosthetic divisions to form Fillauer, Inc.



1996 – 1999

Fillauer begins a steady expansion, acquiring such companies as Hosmer, in 1996, and Motion Control, in 1997, which collectively brings in a strong upper-extremity product line, both body powered and myoelectric. The Center for Orthotic Design, acquired in 1999, develops a new version of the reciprocating gait orthosis.



Top: The Hosmer 5XA Hooks

Bottom: The Motion Control ETD and Hybrid Arm



Trautman™ Bench Carver



Dynamic Walk

2000s

Fillauer continues expansion, acquiring Swedish-based Centri AB in 2002, adding gloves, liners, and protective leg coverings, in addition to other orthotic and prosthetic components. In 2005, the Trautman™ equipment line is added to Fillauer LLC. In 2008, Fillauer started Emotis, its first joint venture, which uses advanced composite materials to produce prosthetic feet. Most recently, in 2009, Fillauer purchases OTS Corp., a high-end provider of orthotic componentry, including the StepLock knee joint, and PDQ® Ovens for O&P fabrication.



PDQ® BT-4 Oven



AllPro Foot

2017

Today, Fillauer's mission is to be a leader in the evolution, design, and technology of orthotic and prosthetic products and services that empower clinicians and patients to achieve their best functional outcomes.

Led by the fourth generation, Michael Fillauer, CPO/L is President & CEO of Fillauer Companies, Inc. where he and his brother David Fillauer serve on the board. Fillauer encompasses Fillauer LLC, Motion Control, Fillauer Composites (formerly Emotis), Fillauer North Carolina (formerly OTS Corp.), Fillauer Europe (formerly Centri), and Fillauer Orthotics and Prosthetics.

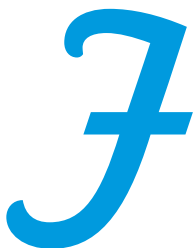

Fillauer US Limited Warranty

Fillauer items under warranty will be replaced or repaired (at Fillauer's discretion) at no charge, if the mat in the event of a defect, malfunction or other failure of the product during the warranty period, not caused by any of those items set forth in Exclusions below, Fillauer shall quickly remedy such failure or defect within a reasonable period of time. The remedy shall consist of repair or replacement of the product at Fillauer's sole discretion. Replacement units may be either new or reconditioned units in near-new condition. Determination of the damages or defects to be covered under the Limited Warranty shall be made by Fillauer. The customer is responsible for shipping costs to Fillauer, and Fillauer shall pay return shipping costs to customer. Consumables are not warranted.

Exclusions

The warranty does not include:

1. Wear and tear.
2. Use, fabrication or installation outside Fillauer's recommendations.
3. Orthotic and Prosthetic services for fitting and maintaining the orthosis or prosthesis made and used with the equipment.
4. Damage caused by neglect, misuse or improper operation.
5. Damage due to accident, fire, water, vandalism, unsuitable environmental conditions, or parts not approved or recommended by Fillauer.
6. Modifications to the product which occur during the warranty period except by mutual consent of the parties in writing.

Orthotic and Prosthetic Components, Equipment, and Custom Fabrication Items

are warranted for 12 months from the date of shipment from a Fillauer warehouse or from an authorized Fillauer distributor with the following exceptions:

Oven heating elements, Suspension Sleeves and Silicone Gloves

are warranted for 90 days from the date of shipment from a Fillauer warehouse or from an authorized Fillauer distributor.

Prosthetic Liners, Dream Skin, Cosmetic Gloves, Tools, and Trautman Accessories

are warranted for 6 months from the date of shipment from a Fillauer warehouse or from a Fillauer authorized distributor.

Hosmer Hooks and Elbows, Motion Arm, Utah Arm, E2 Elbow and ProControl 2

are warranted for 24 months from the date of shipment from a Fillauer warehouse or from a Fillauer authorized distributor. Extended warranties of two years are also available.

Repairs

made by Fillauer are warranted for 90 days from the date of shipment from a Fillauer warehouse or from a Fillauer authorized distributor.

Feet

are warranted for 12, 24, or 36 months from the date of patient fitting.

12 months: Obsidian Blades

24 months: Formula

36 months: AllPro, AllPro XTS, Aeris Performance 2, Aeris Performance LP, Ibex XD, Element, and Wave Comfort 3

Foot Shell and ProCover

are warranted for 9 months from the date of patient fitting.

Taska™ Hands

are warranted for 3 years from the date of patient fitting. Extended warranties available.

Returns, Adjustments, and Credits

- Inspect all goods immediately upon receipt for damage or errors in shipping.
- Call Customer Service within five business days in the event of errors or damage.
- Prior approval and an RMA number must be obtained from Customer Service before goods may be returned.
- Returns must be accompanied by a copy of original invoice, order number, or PO number. The return authorization number, provided by Customer Service, must appear on the shipping label.
- Credit for returned merchandise is subject to inspection and may be subject to a 15% restocking fee for merchandise in resalable condition if returned within 90 days.
- No credit shall be issued for goods returned after 90 days.
- No credit shall be issued for equipment, custom or special order items, including Taska Hands.
- No credit shall be issued for non-stock items returned after 30 days.

Contents

Tools, Equipment, & Materials

Fillauer US Limited Warranty	6
------------------------------	---

Trautman Carvers & Sanders

Trautman Arbor 5001	10
Trautman Double Drum Sander	11
Trautman Single Speed Floor Carver	12
Trautman Variable Speed Floor Carver	13
Dust Collector Attachment for Floor Carver	14
Dust Collection Hose Kit for 2100L	14
Air Attachment for Floor Carver	15
Accessory Holder for Floor Carver	15
Foot Switch for 115 V Carvers	16
Lift Assist Kit for Floor Carver	16
Trautman Variable Speed Bench Carver	17
Trautman Single Speed Bench Carver	17
Bench Carver Floor Stand	18
Accessory Holder for Bench Carver	18
Dust Collector for Bench Carver	18
Drill Attachments ½-13 Thread	19
Cutters & Replacement Blades	19
Router Adapters	19
Trautman Coneiak Polishing Arbors	20
Dual Purpose Expansion Arbors	22
Expansion Arbors	23
Tapered Felt Arbor / Core	24
Urethane and Felt Arbors	25
Tycro Polishing Arbors	25
Soft Foam Shaper	26
Shaft Foam Arbors	26
Rubber Sand Cones	27
Pneumatic Sand Drum	28
Sand Drum	28
Grinding Rasps	29

Trautman Vacuum Systems

Mobile Vacuum Unit	32
Trautman Tech Station	33
Trautman Vacuum Stations	34
Holding Frames	34
Portable Oilless Vacuum Pump	35
Vacuum Control Assembly	35
Drape Forming Adapters	36
TFC Consolidation Stand	36

PDQ® Ovens

PDQ® BT-4 Infrared Oven	38
PDQ® Rollabout Oven	39
PDQ® PO-2 Infrared Oven	40
PDQ® Oven Fan Kit	40
PDQ® Bubble Forming Frames	41
PDQ® Bubble Forming Stand	41
PDQ® Oven Gloves	41

Fabrication Equipment

Laminating Fixture LJ-100	44
Surgical Tubing	44
Vertical Fabrication Fixture, VFJ-100	45
Bar Contouring Device	46
Pipe Holding Fixtures	46
Prosthetic Bench Vise	47
Cable Swaging Tool	47
Drill Press Fixture	48
Universal Alignment Fixture	48
Stirrup Bender	49
Contouring Fork and Bench Receptacle	49
Joint Alignment Tool	49
Bending Irons	50
Contouring Irons	50
Rivet Bar	50
Spring Clamps	51
Yates Clamps	51
Revolving Punch	52
Scissors	52
Steinel® Heat Gun	53
PVA Electric Sealer	53
Scarpas Knife	54
Surgical Scalpel	54
Heavy-Duty Retractable Utility Knife	54
Deburring Tool	55
Tube Cutter	55
Cutting Tool for 30 mm Carbon Fiber Tube	55
Cast Cutter	56
Pneumatic Cast Cutter	56
Cast Spreaders	56
Cast Mandrels	57
Surform™ Files	57
Measuring Tapes	57
Ruler and Rivet Gauge	58
Transtibial Length Gauge	58
Original AP-ML Gauge	58
Universal AP-ML Gauge	58

Transfemoral Length Gauge 59

Goniometer 59

Casting Fixture Gauge 59

Rubber Mixing Bowls 60

Rounded Blade Spatula 60

Adjustable PVA Bag Pattern 60

Hot Mill Gloves 61

Silicone Hand Roller 61

Electronic Scale 61

Materials

Pe-Lite® 64 – 65

Volara 65

Hook and Loop Fastener 66

Velcro 66

Vinyl-Reinforced Velcro Straps 67

Cleani-Stump Antiseptic Wipe 67

Isolation Bags 68

PolyCar-C Sheets 68

Dacron Tape 69

Casting Socks 69

Transfer Paper 70

Thermoformable Composite (TFC) Sheets 71

Thermoformable Composite (TFC) Insole 72

Bars 73

TFC Upright Bars & Silicone Forming Sleeve 73

Teflon Sheet 74

Silicone Sheet 74

Index by Description 75

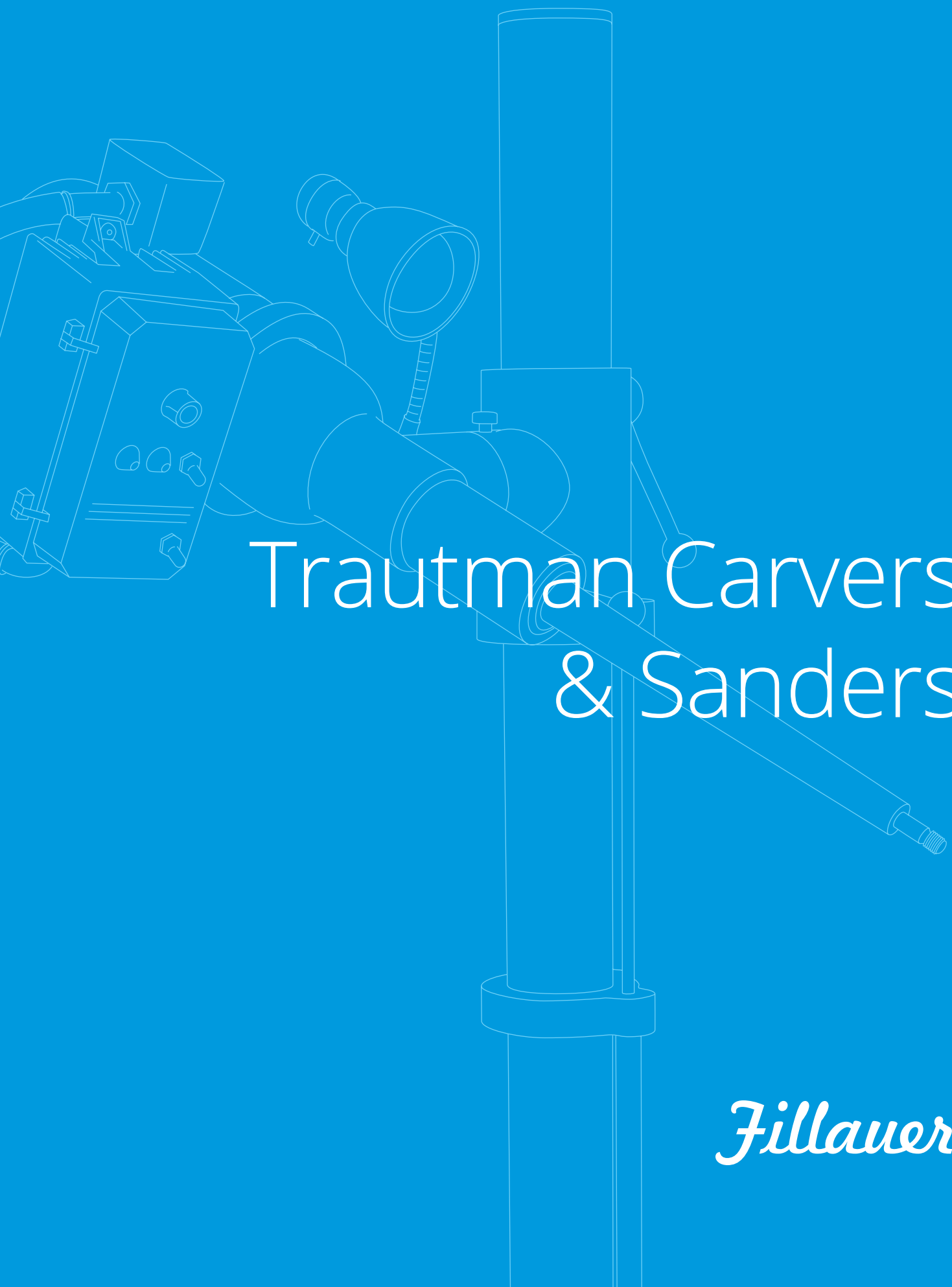

Trautman Carvers & Sanders

Fillauer®

Trautman Arbor 5001

Specifications

Height: 48 in. (122 cm)

Weight: 560 lbs. (254 kg)

Width: 47 in. (119 cm)

Speed: 1725 rpm

Base plate: 25 × 20 in. (635 × 508 mm)

Thread: ½-13



Product Features

The 5001 Trautman Arbor has powerful Baldor 2 HP, 60 HZ, 1 phase 115/230 V or 230/460 V motor. It comes with a 14 in. (350 mm) disc and an 8 in. (200 mm) pneumatic sanding drum.

- Dual drive belts
- 2 horse power, Baldor® motor
- 1725 rpm at 60Hz
- Durable powder coated finish

Ordering Information

Trautman Arbor

Description	Product Number
Trautman Arbor, Single Phase, 60Hz, 115 V	5001-1
Trautman Arbor, Single Phase, 50Hz, 230 V	5001-1-50
Trautman Arbor, Three Phase, 60Hz, 230 V	5001-3
Trautman Arbor, Three Phase, 50Hz, 460 V	5001-3-50

Sand Disc

Description	Product Number
Sand Disc, 24 Grit	A24

Sand Cones For Non-Pneumatic Drums

Description	Product Number
Sand Drum Sleeve, 24 Grit	S24
Sand Drum Sleeve, 50 Grit	S50
Sand Drum Sleeve, 120 Grit	S120
Sand Drum Sleeve, 180 Grit	S180
Sand Drum Sleeve, 240 Grit	S240

Sand Drum Sleeves—Pneumatic

Description	Product Number
Sand Drum Sleeve Fine-120 Grit	225247
Sand Drum Sleeve Fine-100 Grit	225248
Sand Drum Sleeve Coarse-36 Grit	225249

Trautman Double Drum Sander

Specifications

Height: 44 in. (112 cm)

Weight: 535 lbs. (243 kg)

Width: 45 in. (114 cm)

Speed: 1725 rpm

Product Features

The Trautman 5005 DD Sander comes with same motor, motor control, dual drive belts with guard, and base as 5001 Arbor. This machine has two 9 in. (23 cm) pneumatic sanding drums.

- Dual drive belts
- 2 horse power, Baldor® motor
- Durable powder coated finish



Ordering Information

Trautman Double Drum Sander

Description	Product Number
Trautman Arbor, Single Phase, 60Hz, 115 V	5005-1
Trautman Arbor, Single Phase, 50Hz, 230 V	5005-1-50
Trautman Arbor, Three Phase, 60Hz, 230 V	5005-3
Trautman Arbor, Three Phase, 50Hz, 460 V	5005-3-50

Sand Cones For Non-Pneumatic Drums

Description	Product Number
Sand Drum Sleeve, 24 Grit	S24
Sand Drum Sleeve, 50 Grit	S50
Sand Drum Sleeve, 120 Grit	S120
Sand Drum Sleeve, 180 Grit	S180
Sand Drum Sleeve, 240 Grit	S240

Sand Drum Sleeves—Pneumatic

Description	Product Number
Sand Drum Sleeve Fine-36 Grit	225185
Sand Drum Sleeve Fine-120 Grit	225194

Trautman Single Speed Floor Carver

Specifications

Height: 63 in. (160 cm)

Working Height: 26 – 56 in. (66 – 142 cm)

Weight: 219 lbs (99 kg)

Speed: 3450 rpm, 115 V (2860 rpm, 230 V)

Thread: ½-13

Product Features

- Durable ½ hp Baldor® Motor
- Brushless motor for low maintenance
- Motor is thermally protected to prevent damage from overheating
- Factory lubricated and sealed bearings for long-lasting use
- Pre-attached 40 watt work light for the 60 Hz machine
- Fully adjustable height and tilt
- Torque overload safety feature
- ¾-11 threaded accessories may be used with Trautman Router Adapter, PN 225029



Floor Carver
shown with Carver
Lift Assist

Ordering Information

Trautman Single Speed Floor Carver

Description	Product Number
Trautman Floor Carver, Single Speed, 60 Hz, 115 V	2100/60
Trautman Floor Carver, Single Speed, 50 Hz, 230 V	2100/50
Anchor Bolt System	390900
Carver Lift Assist for Floor Carver	2100LA
Accessory Holder	2300M

Trautman Variable Speed Floor Carver

Specifications

Height: 63 in. (160 cm)

Working Height: 26 – 56 in. (66 – 142 cm)

Weight: 228 lbs. (103 kg)

Speed: 1380 – 3450 rpm, 115 V (1380 – 2860 rpm, 230 V)

Thread: ½-13 or ⅝-11

Product Features

- Precise speed control for best results possible
- Heavy duty ¾ hp Baldor® motor and controller
- Brushless motor for low maintenance
- Motor is thermally protected to prevent damage from overheating
- Factory lubricated and sealed bearings for long-lasting use
- Pre-attached 40 watt work light for the 60 Hz machine
- Fully adjustable height and tilt
- Torque overload safety feature
- Heavy duty base for stability

Ordering Information

Trautman Variable Speed Floor Carver

Description	Frequency	Thread	Product Number
Trautman Floor Carver	60 Hz, 115 V	½-13	2300/60
Trautman Floor Carver	50 Hz, 230 V	½-13	2300/50
Anchor Bolt System			390900
Carver Lift Assist for Floor Carver			2100LA
Accessory Holder			2300M



Floor Carver
shown with Carver
Lift Assist

Dust Collector Attachment for Floor Carver

Product Features

- Infinitely adjustable
- Steel construction
- 4 in. (10 cm) exhaust for connection to vacuum system



Ordering Information

Description	Product Number
Dust Collector for Floor Carver	2100L

Dust Collection Hose Kit for 2100L

Product Features

- For use with Dust Collector for Floor Carver (PN 2100L)
- 4 in. (10 cm) diameter clear hose for viewing any obstruction
- 6 ft. (1.8 m) of flexible hose reach
- 2 worm-drive clamps for connection
- Internal abrasion resistant
- Enclosed steel wire reinforced



Ordering Information

Description	Product Number
Dust Collection Hose Kit for 2100L	226005

Air Attachment for Floor Carver

Product Features

The air attachment directs an adjustable air stream to blow dust and chips from the cutting tool and to assist in cooling down thermoplastic grinding for more efficient grinding. Standard ¼ in. (0.6 cm) pipe fitting to be attached to your air supply.

- Features a flat air flow nozzle
- Flexible stay set hose for adjustable air stream



Ordering Information

Description	Product Number
Air Attachment for Floor Carver	2100J

Accessory Holder for Floor Carver

Product Features

- Round, rotatable carousel design
- Keeps accessories organized, visible, and accessible
- 23 total peg locations, includes 8 long and 23 short pegs for custom peg layouts



*Accessories sold separately

Ordering Information

Description	Product Number
Accessory Holder for Floor Carver	2300M

Foot Switch for 115 V Carvers

Product Features

The foot switch allows hands-free stop and start operations for extra safety, convenience, and efficiency.



Ordering Information

Description	Product Number
On/Off Foot Switch Attachment	2100K

Lift Assist Kit for Floor Carver

Product Features

- Assists in both lifting and lowering
- Easy to install
- Provides over 16 in. (40 cm) of adjustment
- Works on all Trautman models, past and current
- Thrust bearing for ease of rotation
- Shock provides slam-resistant damping at the end of the stroke



Ordering Information

Description	Product Number
Carver Lift Assist	2100LA

Trautman Variable Speed Bench Carver

Specifications

Height: 22 in. (56 cm)

Working Height: 15 – 22 in. (38 – 56 cm)

Weight: 28 lbs. (12.7 kg)

Speed: 1380 – 3400 rpm, 115 V (1380 – 2820 rpm, 230 V)

Thread: ½-13 or ⅝-11



Product Features

- Maintenance-free ⅓ hp motor and controller
- High quality variable speed motor controller
- Factory lubricated and sealed bearings for long-lasting use

Ordering Information

Description	Product Number
Trautman Bench Carver, Variable Speed, 60 Hz, 115 V, ½-13 Thread	2600/60
Trautman Bench Carver, Variable Speed, 50 Hz, 230 V, ½-13 Thread	2600/50

Trautman Single Speed Bench Carver

Specifications

Height: 22 in. (56 cm)

Speed: 3400 rpm, 115 V (2820 rpm, 230 V)

Working Height: 15 – 22 in. (38 – 56 cm)

Thread: ½-13 or ⅝-11

Weight: 25 lbs. (11.3 kg)



Product Features

- Great for satellite offices or bench work
- Maintenance free ⅓ hp motor
- Factory lubricated and sealed bearings for long-lasting use
- ⅝-11 threaded accessories may be used with Trautman Router Adapter (PN 225029)

Ordering Information

Description	Product Number
Trautman Bench Carver, 60 Hz, 115 V, ½-13 Thread	2500/60
Trautman Bench Carver, 50 Hz, 230 V, ½-13 Thread	2500/50

Bench Carver Floor Stand

Product Features

- Adjustable height 35 – 56 in. (89 – 142 cm)
- Alloy screw adjusts clamping force



Ordering Information

Description	Product Number
Bench Carver Floor Stand	390190

Accessory Holder for Bench Carver

Product Features

- Keeps accessories organized, visible, and accessible



Ordering Information

Description	Product Number
Accessory Holder for Bench Carver	2500M

Dust Collector for Bench Carver

Product Features

- Works with most workshop vacuum systems
- Flexible gooseneck for wide range of adjustment
- Appropriate for bench carvers and for hand-held sanding tools



Ordering Information

Description	Product Number
Dust Collector for Bench Carver	2500L

Drill Attachments 1/2-13 Thread

Ordering Information

Product features	Product Number
Trautman Drill Attachment—Fits up to 3/8 in. shaft	2100S
Trautman Mini Drill Attachment—Fits up to 1/8 in. shaft	2100R



Cutters & Replacement Blades

Ordering Information

Cutters

Description	Product Number
Cutter, 1/2-13 Thread, Large	2100B
Cutter, 1/2-13 Thread, Small	2100H

Replacement Blades

Description	Product Number
Replacement Blades, Large	2100BB
Replacement Blades, Small	2100HB



2100B

2100H

Router Adapters

Ordering Information

1/2-13 Internal Thread

Description	Product Number
5/8-11 External Thread	225029
M16 External Thread	225017

1/2-13 External Thread

Description	Product Number
5/8-11 Internal Thread	225011
M16 Internal Thread	225016



225017

225029

225011

225016

Trautman Coneiak Polishing Arbors

Product Features

- All Coneiak Polishing Arbors work well with any standard thermoplastic materials within the O&P industry
- For best results, drill attachment 2100S (large) or 2100R (small) should be used
- If using a rotary hand tool, the maximum speed should not exceed 5,000 RPMs
- Ensure that the shaft is at least halfway into chuck

Trautman Coneiak Polishing Arbor

Set of Four Coneiaks

Description	Product Number
½-13 Thread	225490
⅝-11 Thread	225495
M16 Thread	225490MM



Tapered Coneiak

Description	Product Number
½-13 Thread	225410
⅝-11 Thread	225415
M16 Thread	225410MM



Ball Nose Coneiak

Description	Product Number
½-13 Thread	225400
⅝-11 Thread	225405
M16 Thread	225400MM



Slim Coneiak

Description	Product Number
½-13 Thread	225440
⅝-11 Thread	225445
M16 Thread	225440MM



Cylindrical Coneiak

Description	Product Number
½-13 Thread	225450
⅝-11 Thread	225455
M16 Thread	225450MM



Hourglass Coneiak

Description	Product Number
½-13 Thread	225430
⅝-11 Thread	225435
M16 Thread	225430MM



Grooved Coneiak

Description	Product Number
½-13 Thread	225420
⅝-11 Thread	225425
M16 Thread	225420MM

**Double Durometer**

Description	Product Number
½-13 Thread	225460
⅝-11 Thread	225465
M16 Thread	225460MM

**Coneiak Mini Polishing Arbor****Set of Five Coneiak Minis**

Description	Product Number
⅛ in. Shaft	225650

**Tapered Coneiak Mini**

Description	Product Number
⅛ in. Shaft	225600

**Ball Nose Coneiak Mini**

Description	Product Number
⅛ in. Shaft	225615

**Slim Coneiak Mini**

Description	Product Number
⅛ in. Shaft	225605

**Cylindrical Coneiak Mini**

Description	Product Number
⅛ in. Shaft	225620

**Double Ended Coneiak Mini**

Description	Product Number
⅛ in. Shaft	225610



Dual Purpose Expansion Arbors

Product Features

- Sand and polish without changing tools
- Removable, tapered polishers for easy replacement

Ordering Information

Small



Small Dual Purpose

Description	Product Number
½-13 Threads	225330
⅝-11 Threads	225335
M16 Threads	225330MM
Slim Blue Coneiak, Replacement tip	225345

Small Sanding Sleeves

Description	Product Number
Small 24 Grit	D24
Small 80 Grit	D80
Small 120 Grit	D120

Medium



Medium Dual Purpose

Description	Product Number
½-13 Threads	225320
⅝-11 Threads	225325
M16 Threads	225320MM
Tapered Red Coneiak, Replacement tip	225340

Medium Sanding Sleeves

Description	Product Number
Medium 24 Grit	C24
Medium 80 Grit	C80
Medium 120 Grit	C120
Medium 180 Grit (metal use)	C180
Medium 240 Grit (metal use)	C240
Medium 320 Grit (metal use)	C320

Expansion Arbors

Product Features

- Expands while in use to apply inside pressure to the sanding sleeve to hold it in place
- Prevents migration and “fly away” of sanding sleeve
- Provides a smoother grinding surface for straighter lines and higher quality finish
- Eliminates grinding chatter
- Sold individually or as a kit of three
- Available in ½-13, ⅝-11 and M16 threads to fit most O&P machinery



Ordering Information

Expansion Arbor Kits

Description	Product Number
½-13 Threads	225380
⅝-11 Threads	225385
M16 Threads	225380MM

Mini



Mini Expansion Arbor

Description	Product Number
½-13 Thread	225350
⅝-11 Thread	225360
M16 Thread	225350MM

Mini Sanding Sleeves

Description	Product Number
Mini 50 Grit	P50
Mini 100 Grit	P100
Mini 180 Grit	P180

Small



Small Expansion Arbor

Description	Product Number
½-13 Thread	225352
⅝-11 Thread	225362
M16 Thread	225352MM

Small Sanding Sleeves

Description	Product Number
Small 24 Grit	D24
Small 80 Grit	D80
Small 120 Grit	D120

Medium



Medium Expansion Arbor

Description	Product Number
½-13 Thread	225354
⅝-11 Thread	225364
M16 Thread	225354MM

Medium Sanding Sleeves

Description	Product Number
Medium 24 Grit	C24
Medium 80 Grit	C80
Medium 120 Grit	C120
Medium 180 Grit (metal use)	C180
Medium 240 Grit (metal use)	C240
Medium 320 Grit (metal use)	C320

Tapered Felt Arbor / Core



Ordering Information

1 × 4 in. Felt Arbors & Sand Cones

Description	Product Number
Tapered Felt Arbor, 1 × 4 in., ½-13 Thread	225072
1 × 4 in. Sand Cone, 80 Grit	225173
1 × 4 in. Sand Cone, 120 Grit	225175

1.5 × 4 in. Felt Arbors & Sand Cones

Description	Product Number
Tapered Felt Arbor, 1.5 × 4 in., ½-13 Thread	225070
Tapered Felt Arbor, 1.5 × 4 in., ⅝-11 Thread	225177
1.5 × 4 in. Sand Cone, 36 Grit	225151
1.5 × 4 in. Sand Cone, 100 Grit	225169
1.5 × 4 in. Sand Cone, 120 Grit	225171

2 × 4 in. Felt Arbors & Sand Cones

Description	Product Number
Tapered Felt Arbor, 2 × 4 in., ½-13 Thread	225068
2 × 4 in. Sand Cone, 36 Grit	225136
2 × 4 in. Sand Cone, 80 Grit	225141

Urethane and Felt Arbors

Product Features

- Urethane Arbors: Most commonly used for shaping soft foam covers
- Felt Arbors: Used for polishing plastic edges
- Can be shaped to any contour



225080

Ordering Information

Urethane Features

Description	Product Number
Urethane Arbor, 3 × 5 in., 5/8-11 Thread	225080
Urethane Arbor, 3 × 5 in., 1/2-13 Thread	225082
Urethane Arbor, 1.5 × 4.5 in., 5/8-11 Thread	225520

Tycro Polishing Arbors



225110



225100

Ordering Information

Tycro Polishing Arbor

Description	Product Number
Tycro Polishing Arbor, 3 × 3 1/2 in., Double Ended with 5/8 in. and 1/2 in. Thread	225110

Tycro Accessories

Description	Product Number
Tycro Cone, 4 × 1 in. (Requires 225090)	225100
Tycro Cone Adapter, 1/2 in. Thread	225090

Soft Foam Shaper

Specifications

Length: 5 in. (12 cm)

Max. Diameter Schmid Carver: 2 3/4 in.

Thread: 5/8-11



Product Features

- Ideal for contouring both inner and outer areas of foam cover
- Fine steel bristles barely protrude through surface so foam material may be shaped quickly and removed to obtain the desired cosmetic finish
- Trautman Router Adapter required (PN 225029)

Ordering Information

Description	Product Number
Soft Foam Shaper	51391

Shaft Foam Arbors



Ordering Information

Foam Arbor for Floor Carver

Description	Product Number
Shaft Foam Arbor for Floor Carver, 3 x 9 in.	2100X

Foam Arbor for Bench Carver

Description	Product Number
Shaft Foam Arbor for Bench Carver, 3 x 5 1/2 in.	2500X

2100X Sand Cones

Description	Product Number
Sand Cone for 2100X, 36 Grit	225240
Sand Cone for 2100X, 60 Grit	225242
Sand Cone for 2100X, 120 Grit	225244

2500X Sand Cones

Description	Product Number
Sand Cone for 2500X, 36 Grit	225230
Sand Cone for 2500X, 60 Grit	225232
Sand Cone for 2500X, 120 Grit	225234

Rubber Sand Cones

Specifications

Length: 4 $\frac{3}{8}$ in. (111 mm)

Thread: $\frac{1}{2}$ -13

Mini Sand Core



Mini Sand Core

Description	Product Number
Sand Core, Mini	2100P

Mini Sanding Sleeves

Description	Product Number
Mini 50 Grit	P50
Mini 100 Grit	P100
Mini 180 Grit	P180

Mini Polishing Cone

Description	Product Number
Mini, Fine, Blue	225117
Mini, Medium, Maroon	225118
Mini, Coarse, Brown	225119

Small Sand Core



Small Sand Core

Description	Product Number
Sand Core, Small	2100D

Small Sanding Sleeves

Description	Product Number
Small 24 Grit	D24
Small 80 Grit	D80
Small 120 Grit	D120

Small Polishing Cone

Description	Product Number
Small, Fine, Blue	225111
Small, Medium, Maroon	225112

Medium Sand Core



Medium Sand Core

Description	Product Number
Sand Core, Medium	2100C

Medium Sanding Sleeves

Description	Product Number
Medium 24 Grit	C24
Medium 80 Grit	C80
Medium 120 Grit	C120
Medium 180 Grit	C180
Medium 240 Grit	C240
Medium 320 Grit	C320

Medium Polishing Cone

Description	Product Number
Medium, Fine, Blue	225114
Medium, Medium, Maroon	225115
Medium, Coarse, Brown	225116

Pneumatic Sand Drum

Ordering Information

Pneumatic Sand Drum 3.5 × 5 in.

Description	Product Number
Pneumatic Sand Drum, ½-13 Thread	224100



Sand Drum Sleeves—Pneumatic

Description	Product Number
Sand Sleeve, 120 Grit	224101
Sand Sleeve, 80 Grit	224102
Sand Sleeve, 36 Grit	224103

Sand Drum

Ordering Information

Sand Drum—Small, 3 in. Long

Description	Product Number
Barrel Shape, Small, ½-13 Thread	2100F

Replacement Parts

- R2100F-DC - Drum Cover, Foam Rubber
- R2100F-DB - Hold Down Bar



Sand Sheets—Small

Description	Product Number
Sand Sheet, 60 Grit	F60
Sand Sheet, 120 Grit	F120

Sand Drum—Large, 3.5 in. Long

Description	Product Number
Barrel Shape, Large, ½-13 Thread	2100G

Replacement Parts

- R2100G-DC - Drum Cover, Foam Rubber
- R2100G-DB - Hold Down Bar

Sand Sheets—Large

Description	Product Number
Sand Sheet, 60 Grit	G60
Sand Sheet, 120 Grit	G120

Grinding Rasps

Product Features

- High-quality steel
- Sharp teeth
- Long usage
- Designed for long-term use

Ordering Information

5/8-11 Thread*

Description	Product Number
1 1/2 x 2 1/4 in. - Use on Transtibial Sockets, Coarse	225052
1 3/8 x 3 3/8 in. - Small Diameter and Channel Work, Coarse	225045
1 3/8 x 2 1/8 in. - Extra Fine	225060
1 3/4 x 3 1/8 in. - General Transfemoral Socket Work, Coarse	225037

*Must have router adapter for 5/8-11 threaded Rasps

1/2-13 Thread

Description	Product Number
Rasp	2100E
Carbide Grind Rasp, Large, Coarse	225252
Carbide Grind Rasp, Large, Fine	225256
Carbide Grind Rasp, Small, Coarse	225262
Carbide Grind Rasp, Small, Fine (Used most commonly for grinding laminated sockets)	225266

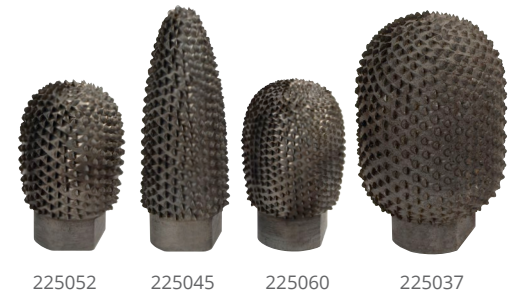

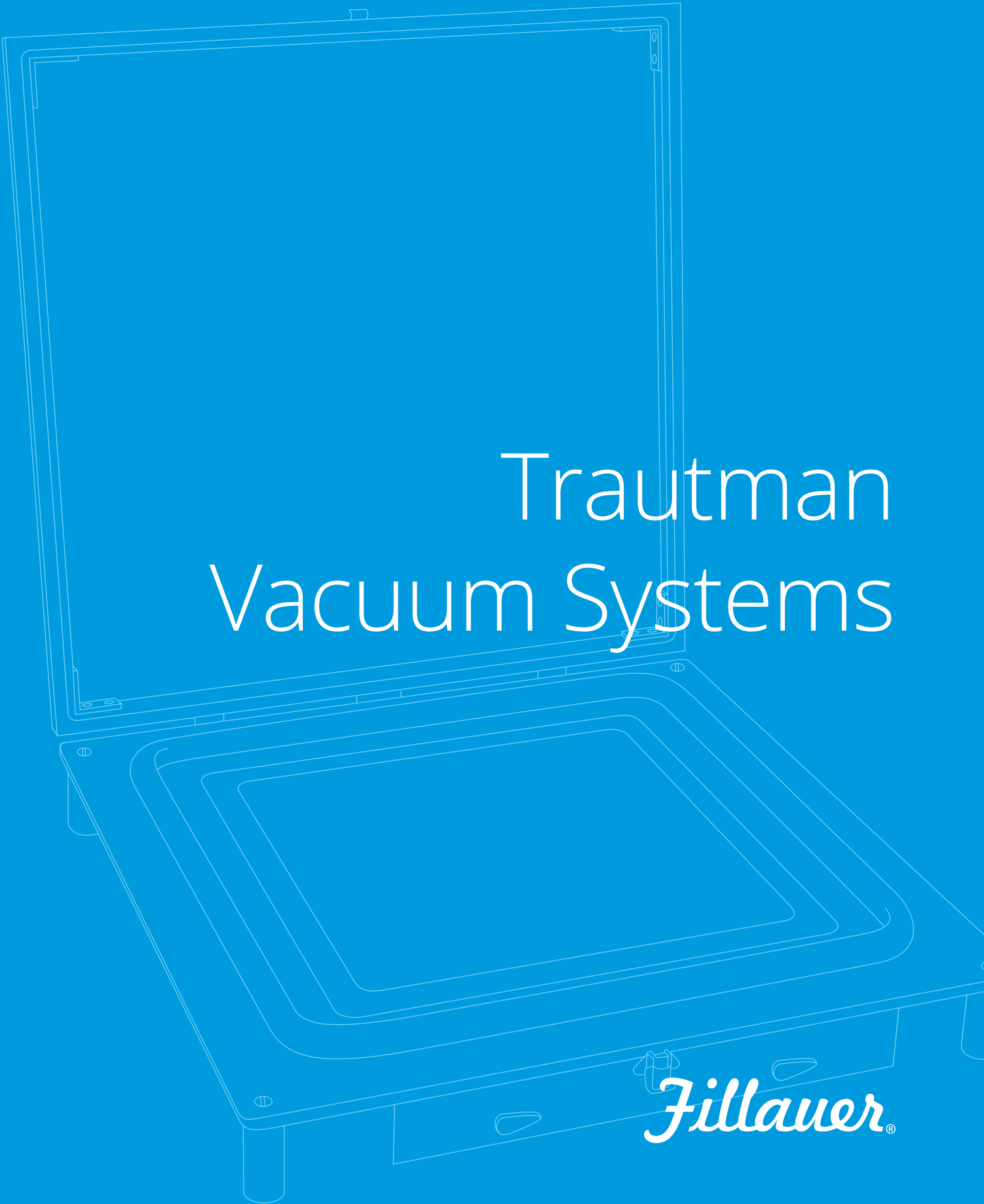
A white line drawing on a blue background showing a vacuum chamber with its lid open. The lid is hinged at the top and is tilted upwards. The chamber has a thick, multi-layered door with a handle on the right side. The interior of the chamber is empty.

Trautman Vacuum Systems

Fillauer®

Mobile Vacuum Unit

Product Features

- Multifunction table top for pipe-mounted platens, vacuum forming, or pipe-holding fixture for horizontal vacuum forming
- Master cut-off valve and three-way valve
 - Neutral (Off) position
 - High vac line—full vacuum direct from vacuum source
 - Low vac line—controlled by regulator
- Veritable On/Off foot pedal
- Filter and water trap (wet plaster models release 4 – 6 oz. of water which could contaminate regulator, gauges, and pump)
- Two 3 gallon surge tanks for rapid vacuum



Ordering Information

Note: Pump is sold separately.

Description	Product Number
Mobile Vacuum Unit	227305
Replacement Parts	
227503 - Surge Tanks	
227511 - Master Cut-Off Valve	
227529 - Three-Way Valve	
227537 - Regulator with 2 in. Gauge	
227545 - Gauge	
227552 - Water Trap	
227560 - On/Off Foot Control	

Trautman Tech Station

Product Features

- State-of-the-art modular, multipurpose workstation
- Small footprint maximizes workspace
- 360-degree rotation with easy adjustments
- Base unit can be modified with various attachments and accessories for custom needs

Ordering Information

Description	Product Number
Trautman Tech Station	395400

Attachments

Description	Product Number
Trautman Tech Pipe Vise	395012
Trautman Tech Pipe Vise with Drop Hitch	395250
Trautman Tech Drape Forming Pipe Holder	395550
Trautman Tech Attachment for Bench Carver	395050
Trautman 12 in. Platen	227347
Trautman 9 in. Platen	227354
Trautman Tech LJ-100 Adapter	395810

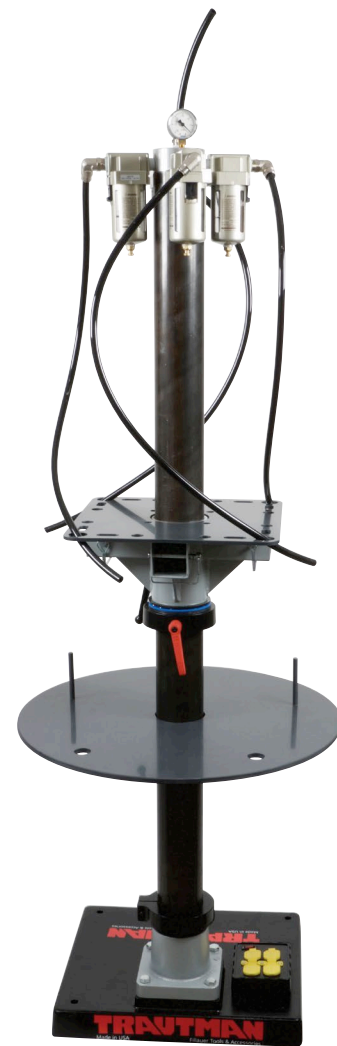

Trautman Vacuum Stations

Product Features

The Trautman Dual Bladder Vacuum Station allows for a variety of options in vacuum forming. The station can be used as either a dual bladder or single bladder vacuum system. The dual bladder configuration allows for better mold preservation during vacuum forming and improved surface quality of the molded product. This allows the product to be more consistent and visually appealing.

Single bladder vacuum stations can be easily upgraded to a dual bladder configuration by purchasing the upgrade kit (see optional accessories below).

- Durable, powder coated, aluminum frame
- High temperature, non-stick, clear silicone bladder
- Dual bladder for use with Comfil® TFC and pre-preg materials
- Quick change outer bladder saves time and money
- Exterior dimension: 24 × 24 in. (61 × 61 cm)
- Work area: 18.5 × 18.5 in. (47 × 47 cm)
- Requires vacuum source



Ordering Information

Trautman Vacuum Stations

Description	Product Number
Dual Bladder Vacuum Station	227730
Single Bladder Vacuum Station	227728

Accessories

Description	Product Number
Dual Bladder Upgrade	227729
Outer Silicone Bladder	227752
Inner Silicone Bladder	227751

Holding Frames

Product Features

- Black powder coated for durability

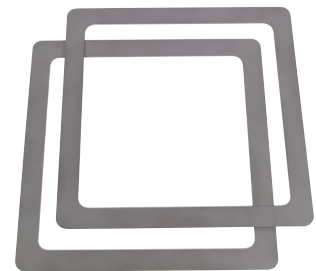

Ordering Information

Note: Sold per pair

Description	Product Number
Holding Frames, 12 × 12 in.	227420
Holding Frames, 16 × 16 in.	227438
Holding Frames, 18 × 18 in.	227443
Holding Frames, 20 × 20 in.	227449
Holding Frames, 22 × 22 in.	227450
Holding Frames, 24 × 24 in.	227451

Portable Oilless Vacuum Pump

Product Features

- 1/3 Horse Power oilless motor
- Enough power to operate two vacuum laminating jigs simultaneously
- 4 cubic feet per minute capacity
- Adjustable vacuum from 3 – 27 in. of mercury (10 – 90 kPa)
- Available in single and dual vacuum
- US plug 115 V, 50/60 Hz Single Phase Motor or EU 230 V, 50 Hz
- Reversible to become air supply as well as vacuum



Ordering Information

Description	Product Number
Portable Single Oilless Vacuum Pump, 115 V	227005
Portable Dual Oilless Vacuum Pump, 115 V	227020
Portable Single Oilless Vacuum Pump, 230 V	227006
Portable Dual Oilless Vacuum Pump, 230 V	227021

Vacuum Control Assembly

Ordering Information

Description	Product Number
Vacuum Control Assembly	227500
Replacement Parts	
227511 - Master Cut-Off Valve	227545 - Gauge
227529 - Three-Way Valve	227552 - Water Trap
227537 - Regulator with 2 in. Gauge	



Drape Forming Adapters



Ordering Information

Drape Forming Adapter

Description	Product Number
Drape Forming Adapter, Straight	227497
Drape Forming Adapter, Angled	227495

Platen

Description	Product Number
9 in. Platen	227354
12 in. Platen	227347

TFC Consolidation Stand

Specifications

- Base measurements: 9.8 × 9.8 in. (250 × 250 mm)
- Height: 16.1 in. (410 mm)



Ordering Information

Description	Product Number
Stand for Vacuum Pipe	600500



PDQ® Ovens

Fillauer®

PDQ® BT-4 Infrared Oven

Specifications

Electrical requirements: US 208 - 240 V single phase, EU 380 - 460 V three phase

Product Features

The BT-4 Infrared Oven is capable of bubble forming and heating sheet plastic while taking up a minimal amount of floor space. The BT-4 is big enough to heat most KAFO sheet plastics and has enough drop for even the biggest check socket.

The BT-4 has the same speed and reliability you've come to expect from PDQ® Infrared Ovens. The eight 1000 watt emitters, four on top and four on bottom, along with the dual electric fans allow bubble forming plastics to be heated evenly and efficiently. The BT-4 is truly the best of both worlds with its small size and large capacity.

- Eight 1000 watt emitters; 4 on top and 4 on bottom
- Programmable digital temperature controller
- Dual electric fans for air circulation
- Access point for vacuum line
- 4 interior lights and large viewing window
- Sheet plastic tray with fitted Teflon® cover
- Aluminum and powder coated protective finish
- 18 in. (46 cm) clearance for bubble forming
- NOTE: US 220 V, single phase ovens delivered without cord
EU 440 V, three phase ovens delivered with cord, no plug



Ordering Information

Model	Interior Dimensions (w × D × H)	Exterior Dimensions	Product Number
PDQ-BT-4	27 × 40 × 24 in. (686 × 1016 × 610 mm)	32 × 49 × 61 in. (813 × 1245 × 1549 mm)	PDQ-BT-4

PDQ® Rollabout Oven

Specifications

Electrical requirements: US 208 – 240 V single phase
EU 380 – 460 V three phase

Weight (uncrated): 500 lbs.

Product Features

A Rollabout model is an excellent solution for heating large sheets of plastic for hip. There are 4 different sizes to meet every thermoforming need, and each features a hydraulic assisted height adjustable tray for easy operation. The tray includes a fitted Teflon® cover, is mounted on casters, and can be rolled to your vacuum area. No more burnt arms or trying to find a place to set down your hot plastic.

- Aluminum and stainless steel construction
- 650 watt infrared emitters (1000 watt on 8E & 8D)
- Double pane viewing window and interior light
- Programmable digital temperature controller
- Tray includes a fitted Teflon® cover

NOTE: 208 – 240 V, single phase ovens delivered without cord
380 – 460 V, three phase ovens delivered with cord, no plug



Shown with the PDQ® Oven Fan Kit.
See page 40 for more information.

Ordering Information

Model	Interior Dimensions (W × D × H)	Exterior Dimensions (W × D × H)	Weight	Product Number US 220 V, 60 Hz, Single Phase	Product Number EU 400 V, 50 Hz, Three Phase
PDQ-5A	38 × 31 × 18 in. (965 × 787 × 457 mm)	49 × 35 × 48 in. (1244 × 889 × 1219 mm)	350 lbs. (159 kg)	PDQ-5A	O 5A-INT
PDQ-6B	36 × 51 × 18 in. (914 × 1295 × 457 mm)	47 × 55 × 48 in. (1194 × 1397 × 1219 mm)	450 lbs. (204 kg)	PDQ-6B	O 6B-INT
PDQ-7C	48 × 51 × 18 in. (1219 × 1295 × 457 mm)	59 × 55 × 48 in. (1499 × 1397 × 1219 mm)	460 lbs. (209 kg)	PDQ-7C	O 7C-INT
PDQ-8E	60 × 50 × 18 in. (1524 × 1219 × 457 mm)	70 × 52 × 48 in. (1778 × 1321 × 1219 mm)	475 lbs. (215 kg)	PDQ-8E	O 8E-INT

PDQ® PO-2 Infrared Oven

Specifications

Electrical requirements: US 208 – 240 V single phase, EU 380 – 460 V three phase

Weight (uncrated): 495 lbs.

Product Features

Designed with banks of lights on top and bottom to facilitate the quick and even forming of thick plastics.

Instead of having to reach into a hot oven for bubble forming frames, the PO-2 model now has a rollabout tray that holds either frames or trays for heating flat plastic. Just roll the cart out to your mold.

- Aluminum and stainless steel construction
- Quartz infrared tubes top and bottom
- Eight 1000 watt quartz infrared tubes (4 on top and 4 on bottom)
- Interior light
- 2 double pane viewing windows
- Programmable digital temperature controller (accurate to within 2°)
- Rollabout bubble forming rack/sheet plastic tray with fitted Teflon® cover
- Bubble Forming Frame (specify size at time of ordering)
- Full 1 year warranty
- NOTE: US 220 V, single phase ovens delivered without cord
EU 440 V, three phase ovens delivered with cord, no plug



Ordering Information

Model	Interior Dimensions (W × D × H)	Exterior Dimensions	Product Number
PDQ-PO-2	50 × 36 × 20 in. (1270 × 914 × 508 mm)	60 × 40 × 53 in. (1524 × 1016 × 1346 mm)	PDQ-PO-2

PDQ® Oven Fan Kit

Product Features

- Available as a retrofit kit for an existing PDQ® Infrared Oven
- Available as factory-installed accessory on a new PDQ® Infrared Oven
- Provides controlled heating of Pre-Preg and TFC materials
- Reduces production time by as much as 20 percent for O&P plastics
- Fits all models except BT-1 and BT-4

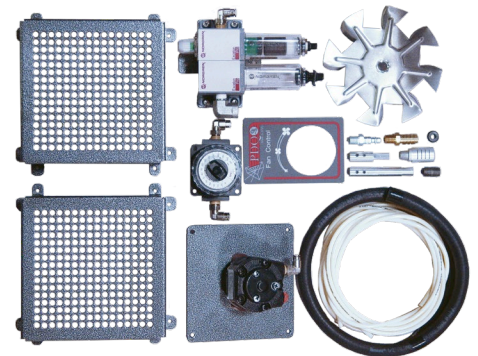

Ordering Information

Description	Product Number
Oven Fan Kit, for Retrofit	OFANKIT
Oven Fan Kit, for Factory Installed Accessory with oven order	OFANNEW

PDQ® Bubble Forming Frames

Product Features

- Round hole to reduce plastic stretch at the corners and increase platen contact
- 4 easy-to-use spring clips to hold plastic in place
- Bottom of frame is wider to facilitate and support frame while inside PDQ® Benchtop Ovens



Ordering Information

Description	Product Number 12 in.	Product Number 16 in.	Product Number 18 in.	Product Number 24 in.
PDQ® Ovens	O-BFF-12-INCH	O-BFF-16-INCH	O-BFF-18-INCH	
BT-4	O-BFF-BT4-12-INCH	O-BFF-BT4-16-INCH	O-BFF-BT4-18-INCH	O-BFF-BT4-24-INCH
BT-3	O-BFF-BT3-12-INCH	O-BFF-BT3-16-INCH	O-BFF-BT3-18-INCH	O-BFF-BT3-24-INCH

PDQ® Bubble Forming Stand

Product Features

This stand can be used in a roll-about PDQ oven to allow for bubble forming. The width of the stand is adjustable to accommodate different sizes of plastic and/or plastic frames for bubble forming.



Ordering Information

Description	Product Number
PDQ® Bubble Forming Stand	O-BFS

PDQ® Oven Gloves

Product Features

- Provides protection against heat up to 250 °F (120 °C)
- 100% cotton
- 11 in. (28 cm) long for up to the elbow coverage



Ordering Information

Description	Product Number
PDQ® Long Thermal Gloves	PDQ-ORSUP-GLOVES

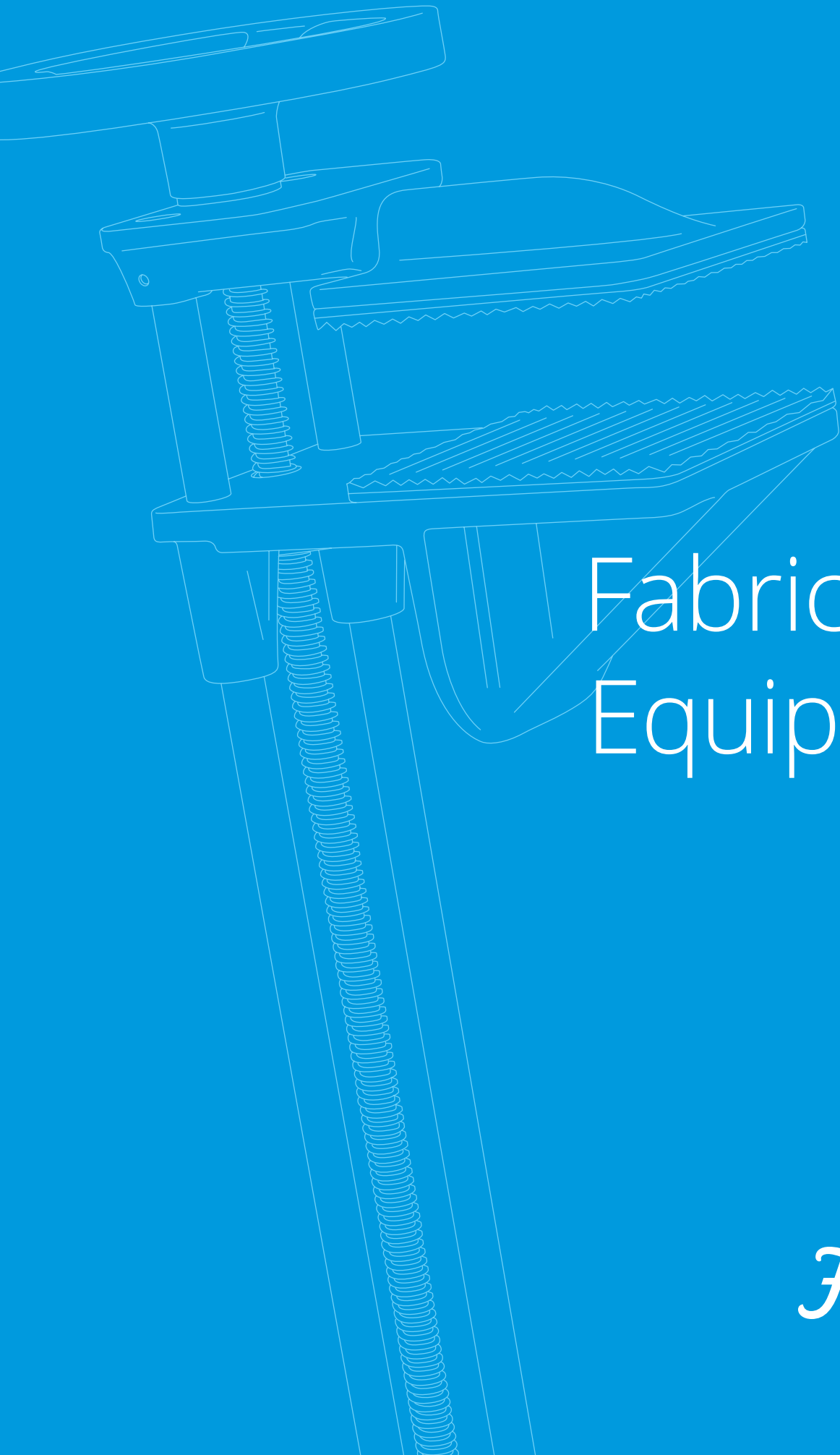

Fabrication Equipment

Fillauer®

Laminating Fixture LJ-100

Specifications

Height: 24 in. (61 cm)

Width: 17 in. (43 cm)

Product Features

- May be positioned to hold cast at any angle or degree of rotation
- Large PVA tie-off ring and hose attachments for inside and outside vacuum lines make laminating easier and faster

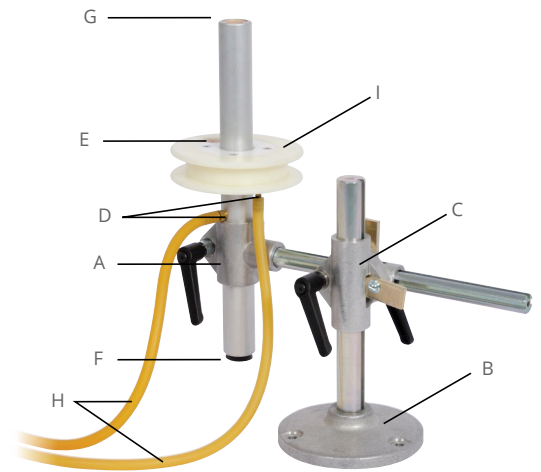

Ordering Information

Description	Product Number
Laminating Fixture Complete, LJ-100	51454
Vacuum Device Assembly Only	51459
Vacuum Laminating Assembly Only	51455

Replacement Parts for LJ100

- A. 51462 - Clamp Assembly
- B. 51463 - Post Base Assembly
- C. 52062 - Clamp Assembly
- D. 51271 - Hose Connector
- E. 51458 - Stopper
- F. 51457 - Plug
- G. 51456 - Pipe Lock
- H. Surgical Tubing (See Below)
- I. 55706 - Lamination Mandrell
- 51275 - Hose, Tie-Off 3/16 in.

Surgical Tubing

Product Features

- High quality, pure latex tubing
- May be used as hose on vacuum or to securely tie-off PVA bags on the Vacuum Laminating Fixture, LJ-100



Ordering Information

Description	Product Number
Surgical Tubing, 0.25 in. (6.4 mm) Diameter, 6 ft. (183 cm) Increments Only	51273
Surgical Tubing, 0.19 in. (4.8 mm) Diameter, per foot	51275

Vertical Fabrication Fixture, VFJ-100

Specifications

Height: 48 ¾ in. (124 cm)

Width: 21 in. (53 cm)

Product Features

- Horizontal operation
- Heavy-duty for long life
- Retractable handle when not in use
- Will form full circle without restriction

Ordering Information

Description	Product Number
Vertical Fabricating Fixture, VFJ-100	52056
Vertical Swivel Module	61714
VFJ-Ball Joint Module	58188
Lutz Adapter Kit, with Endoskeletal Adapters	58641
Flex Foot/Spring Lite LOHO Bock Adapter	58640
Endoskeletal Adapter, (Requires PN 58640)	58633
Posterior Mount Transfer Fixture	52090



Bar Contouring Device

Product Features

Height: 36 in. (914 mm)

Base area: 24 × 38 in. (610 × 965 mm)

Product Features

- Heavy duty
- Retractable handle when not in use
- Operates in two directions, in and out
- Available as floor model (with stand)
- Will form full circle without restriction

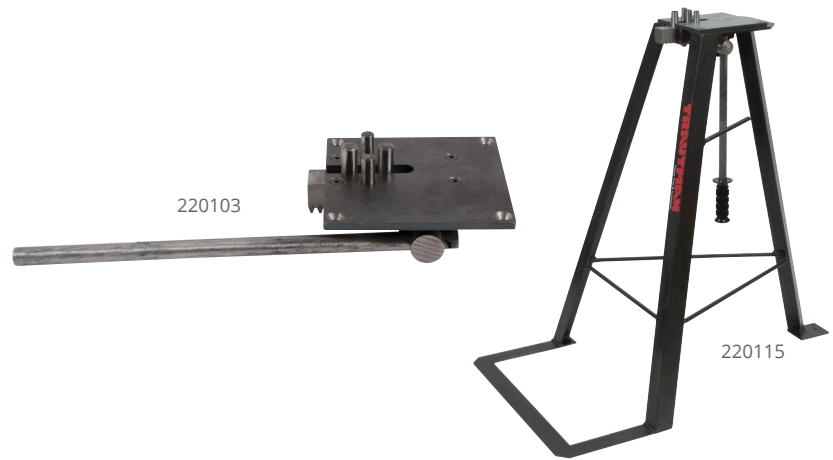

Ordering Information

Description	Product Number
Bar Contouring Device	220103
Bar Contouring Device, with Stand	220111
Stand Only	220115

Pipe Holding Fixtures

Ordering Information

Description	Product Number
Pipe Holding Fixture, Vice Mount	220129
Bench Mounted Pipe Holding Fixture, 8 in. High	220131
Friction Block	220135
Laminating Stand with Pipe Holding Fixture Adjustable in Height to 60 in. (152 cm), 15 - 18 in. (381 - 457 mm) Diameter	220133



Prosthetic Bench Vise

Product Features

- Tough, resilient pads
- Opens to 16 in. (406 mm) with an 8 in. (203 mm) depth
- Swivel jaw, 6 × 6 in. (152 × 152 mm)



Ordering Information

Description	Product Number
Prosthetic Bench Vise	220178
Replacement Pads	220301

Cable Swaging Tool

Product Features

- May be used in any standard bench vise
- Made of heat treated steel



Ordering Information

Description	Product Number
Cable Swaging Tool, for Three Sizes of Cable Size Fittings	50520

Replacement Die

Description	Product Number
Replacement Die, $\frac{3}{64}$ in. (0.119cm)	50524
Replacement Die, $\frac{1}{16}$ in. (0.159cm)	50523
Replacement Die, $\frac{3}{32}$ in. (0.238cm)	50522

Drill Press Fixture

Product Features

- For intricate orthotic and prosthetic work
- Less bulky than a table



Ordering Information

Description	Product Number
Drill Press Fixture, 2 - 2.25 in. (51 - 57 mm) Diameter	220160
Drill Press Fixture, 2.5 - 2.75 in. (64 - 70 mm) Diameter	220162
Drill Press Fixture, 3 - 3.25 in. (76 - 83 mm) Diameter	220164

Universal Alignment Fixture



Ordering Information

Description	Product Number
Universal Alignment Fixture	220128

Stirrup Bender

Specifications

Length: 25 in. (381 mm)

Width capacity: 3 5/8 in. (92 mm)

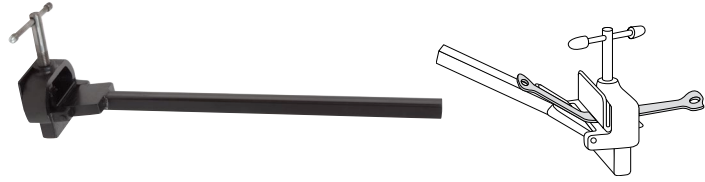

Ordering Information

Description	Product Number
Stirrup Bender	220038

Contouring Fork and Bench Receptacle

Product Features

- Heat-treated stainless steel
- Mounts flush on work bench or in work bench vise

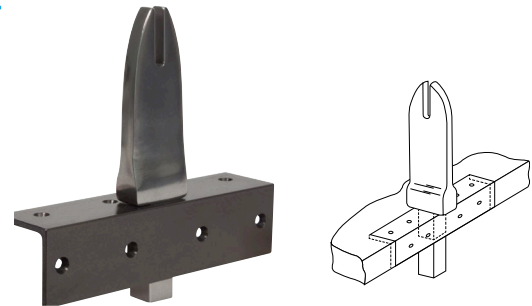

Ordering Information

Description	Product Number
Contouring Fork, 5/16 in. Throat	220194
Contouring Fork, 1/4 in. Throat	220186
Bench Receptacle	220202
Fork and Receptacle Set, 1/4 in. Throat	220210
Fork and Receptacle Set, 5/16 in. Throat	220293

Joint Alignment Tool

Product Features

- Use for both small and large stirrups

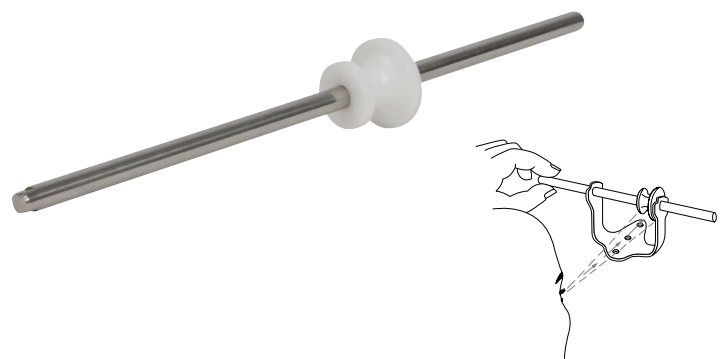

Ordering Information

Description	Product Number
Alignment Tool, Universal 0.25 in. diameter × 8 in. long rod	220020

Bending Irons

Product Features

- 8 in. (203 mm) long, ¼ in. (6.4 mm) thickness capacity
- Stainless steel
- Provides smooth bending of side bars
- Sold as a pair



Ordering Information

Description	Product Number
Bending Irons	54795

Contouring Irons

Product Features

- Nickel plated bronze
- Wide-radius jaws
- Sold as a pair
- Will not mark finished metal or leather work



Ordering Information

Description	Product Number
Rounded Polished Jaws	220285

Rivet Bar

Ordering Information

Description	Product Number
Rivet Bar, with Pins, 27 in.	40010



Spring Clamps



Ordering Information

Description	Product Number
Spring Clamps Set (4 Each)	227594

Yates Clamps

Product Features

- Holds harness during fitting



Ordering Information

Description	Length	Product Number
Clamp Flat Spring		51831
Wire Spring Type, W1 Small	3.1 in. (8 cm)	52115
Wire Spring Type, W2 Medium	3.7 in. (9.5 cm)	52116
Rubber Pads, for 52115 and 52116		52872

Revolving Punch

Hole Sizes

$\frac{3}{32}$ in.	2.4 mm
$\frac{7}{64}$ in.	2.8 mm
$\frac{1}{8}$ in.	3.2 mm
$\frac{5}{32}$ in.	4.0 mm
$\frac{11}{64}$ in.	4.4 mm
$\frac{3}{16}$ in.	4.8 mm



Ordering Information

Description	Product Number
Revolving Punch	155

Scissors



5-514

Ordering Information

Description	Product Number
Bandage Scissors, 5.5 in. (140 mm)	5-514
Bandage Scissors, 7.25 in. (184 mm)	5-516
Bandage Scissors, 8 in. (203 mm)	5-550
Bandage Scissors, 8 in. Heavy-Duty (203 mm)	5-568
TFC Scissors, angled 9.5 in.	600350

Steinel® Heat Gun

Product Features

- 115V US plug
- High Temp—1200 °F (649 °C)
- Digital read-out
- 4 adjustable and programmable heat settings
- Adjustable air flow



Ordering Information

Description	Product Number
Steinel Heat Gun, Model HG2310LCD	34870
14 mm Reducer	600360

PVA Electric Sealer

Product Features

- Teflon covered heat sealer
- Using a small brush, moisten PVA seam to be joined, then seal
- Adjustable heat
- 115 V, 150 watt (AC only)



Ordering Information

Description	Product Number
PVA Sealer, 115 V US plug, PVAS-100	226142
PVA Sealer, 230 V, PVAS-200	226159
Teflon Cover	226175
Wire Clip	226167

Scarpas Knife



Ordering Information

Description	Product Number
Scarpas Knife, Small for Transtibial	220461
Scarpas Knife, Large for Transfemoral	220460

Surgical Scalpel



Ordering Information

Description	Product Number
Scalpel Handle	800050
Blades, Surgical Scalpel, Box (150 Count), #25, 2 in. (51 mm) Long	800060

Heavy-Duty Retractable Utility Knife

Product Features

- Gray enamel finish
- Button projects and retracts blade to 3 positions: full, half, and one-quarter out



Ordering Information

Description	Product Number
Knife, #11-921 Heavy-Duty Retractable Blades, 4 Each	10-099
Heavy-Duty Blade, 2.44 × 0.025 in. (62 × 0.64 mm), 5 Per Pack	11-921

Deburring Tool



Ordering Information

Description	Product Number
Deburring Tool	220321
Deburring Tool, Blade Only	E-100

Tube Cutter

Product Features

- Pocket size pylon cutter with parallel cut control feature
- Cuts all sizes up to 1 1/8 in. (2.9 cm) diameter
- Comes with two extra cutting wheels



220310

60739

Ordering Information

Description	Product Number
Tube Cutter with Heavy Duty Wheels	220310
Heavy-Duty Replacement Wheel	220311
Heavy-Duty Replacement Wheel, for Rigid Cutter	220312
Cutting Guide	60739

Cutting Tool for 30 mm Carbon Fiber Tube



Ordering Information

Description	Product Number
Cutting Tool, for 30 mm Carbon Fiber Tube	731000125

Cast Cutter

Product Features

- Oscillating action quickly cuts through plaster
- Trim plastic sockets and Ortholen splints



Ordering Information

Description	Product Number
Cast Cutter, 115 V	226220
Cast Cutter, 230 V	226226
Cast Cutter Blade, 2.5 in. (64 mm)	226258

Pneumatic Cast Cutter



Ordering Information

Description	Product Number
Pneumatic Cast Cutter (Cast Cutter Blade Not Included)	226228
Cast Cutter Blade, 2.5 in. (64 mm)	226258

Cast Spreaders

Product Features

- For simple removal of larger body casts without pinching
- Four-inch jaw opening in stainless steel construction



Ordering Information

Description	Product Number
Cast Spreader, Small #82	226262

Cast Mandrels



Ordering Information

Description	Product Number
Aluminum Cast Mandrel, 1.75 × 7.5 in. (44 × 190 mm)	259056
Aluminum Cast Mandrel, 2.38 × 7.5 in. (61 × 190 mm)	259060
Aluminum Cast Mandrel, 2.38 × 10 in. (61 × 254 mm)	259053
Aluminum Cast Mandrel, 2.38 × 15 in. (61 × 381 mm)	259050

Surform™ Files

Product Features

- For fast shaping of plaster cast
- Also can be used on wood and plastics



Ordering Information

Description	Product Number
Round File 10 in. (254 mm), Complete	21-297
Flat File 10 in. (254 mm), Complete	21-295
Pocket Plane 6 in. (152 mm), Flat	21-399

Replacement Blades

Description	Product Number
Round Blade	21-291
Flat Blade	21-293
Half Round Blade	21-299

Measuring Tapes



Ordering Information

Description	Product Number
Measuring Tape (Inch/Metric) Fiberglass Retractable, 60 in. (150 cm)	220328
Measuring Tape (Inch/Metric) PVC-Coated, Fiberglass 60 in. (150 cm)	220329
Disposable Measuring Tape, 72 in. (183 cm)	220331

Ruler and Rivet Gauge

Product Features

- Stainless steel



Ordering Information

Description	Product Number
6 in. Ruler	220327

Transtibial Length Gauge

Product Features

- Measures in inches and metric



Ordering Information

Description	Product Number
Transtibial Gauge	220145

Original AP-ML Gauge

Product Features

- Anatomical measuring tool
- Measures in inches and metric



Ordering Information

Description	Product Number
Original AP-ML Gauge, 22 in.	220335

Universal AP-ML Gauge

Product Features

- Anatomical measuring tool
- Measures in inches and metric

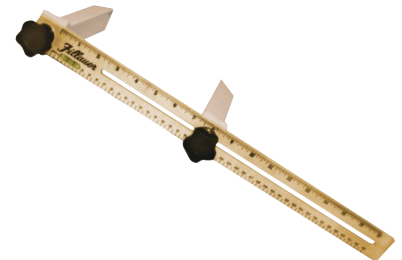

Ordering Information

Description	Product Number
Universal Gauge, with Level, 17 in.	220336

Transfemoral Length Gauge

Product Features

- Measures in inches and metric



Ordering Information

Description	Product Number
Transfemoral Length Gauge	220137

Goniometer

Product Features

- A combination level and adjustable protractor
- Useful when obtaining measurements that are relative to a horizontal plane



Ordering Information

Description	Product Number
Goniometer	51848

Casting Fixture Gauge

Product Features

- For use with the Pelvic casting fixture

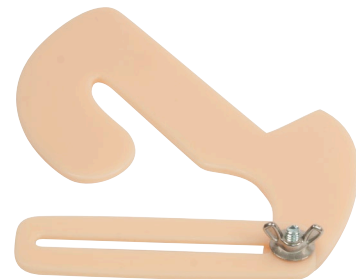

Ordering Information

Description	Product Number
Casting Fixture Gauge	220355

Rubber Mixing Bowls



Ordering Information

Description	Product Number
Rubber Mixing Bowl Set	226050
Includes	
226068 - Rubber Mixing Bowl, 4 Ounce (1.2 dl)	
226084 - 2 Rubber Mixing Bowls, 1 ¼ Pint (6.6 dl)	
226092 - Rubber Mixing Bowl, 1 ½ Quart (1.2 l)	
226100 - Rubber Mixing Bowl, 5 Quart (4.7 l)	

Rounded Blade Spatula



Ordering Information

Description	Product Number
Rounded Blade Spatula 0.75 × 4 in. (19 × 102 mm) ,small	220059
Rounded Blade Spatula 1 × 6 in. (25 × 152 mm), large	220063

Adjustable PVA Bag Pattern

Product Features

- Pattern allows making any shape or length of PVA bag
- Base and angle rod are felt covered aluminum
- Adjusts in one inch increments, up to 13 in. (33 cm) width



Ordering Information

Description	Product Number
PVA Bag Pattern, PVAJ-100	51779

Hot Mill Gloves

Product Features

- Nitrile coated for grip and longer life
- Provides protection against heat up to 250°
- Flexible and strong
- One size fits all



Ordering Information

Description	Product Number
Hot Mill Glove	227008

Silicone Hand Roller



Ordering Information

Description	Width	Product Number
Silicone Hand Roller	1.5 in. (3.8 cm)	600355

Electronic Scale

Product Features

- Battery-powered
- 35 oz. (1000 g)
- Capacity by 2 g (0.1 oz.) increments
- Tare to capacity



Ordering Information

Description	Product Number
Portable Electronic Scale	227100

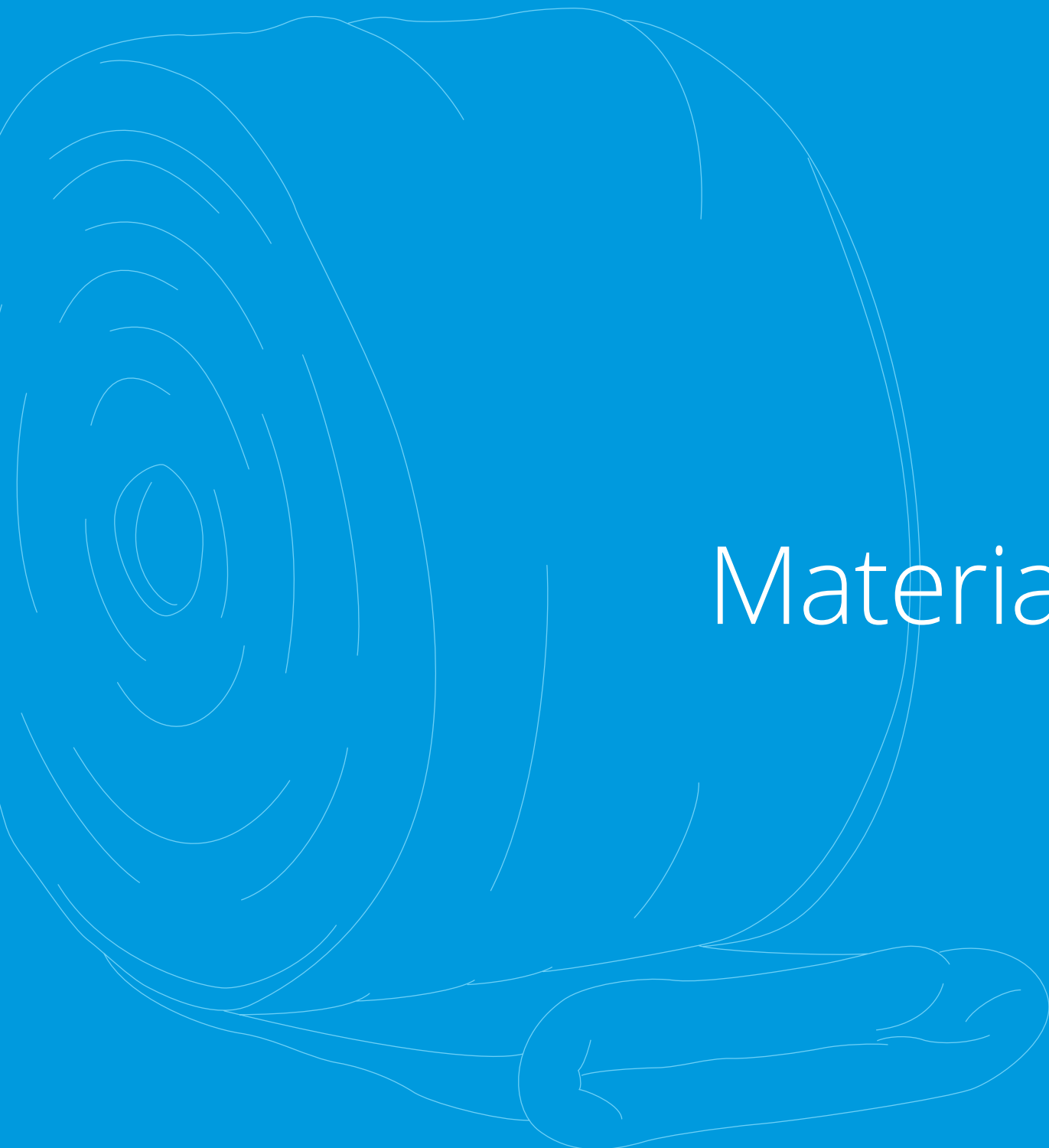

Materials

Fillauer®

Pe-Lite®

Product Features

- Lightweight polyethylene foam sheets in extra-firm, firm, medium, and soft densities
- White, tan, and beige colors
- Soft, non-allergenic
- Non-absorbent
- Thermoplastic- moldable to body shapes

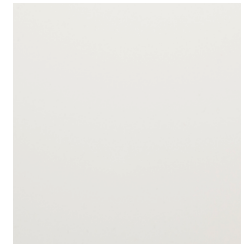

White Non-perforated



White Perforated

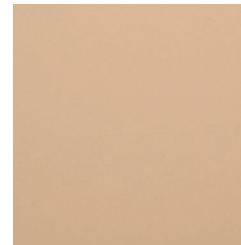

Tan

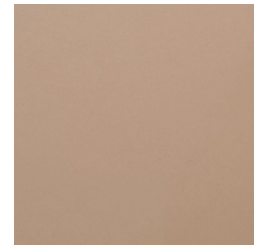

Beige

Ordering Information

Extra-Firm Density Pe-Lite

Description	Color	Thickness	Size	Sheets per Case	Product Number
Non-perforated (A-30)	White	1/16 in. (1.5 mm)	560 × 560 mm (22 × 22 in.)	100	187005
Non-perforated (A-30)	White	1/8 in. (3 mm)	560 × 560 mm (22 × 22 in.)	50	187013
Perforated (A-30)	White	1/16 in. (1.5 mm)	560 × 560 mm (22 × 22 in.)	100	187495
Perforated (A-30)	White	1/8 in. (3 mm)	560 × 560 mm (22 × 22 in.)	50	187500

Firm Density Pe-Lite

Description	Color	Thickness	Size	Sheets per Case	Product Number
Non-perforated (A-20)	White	1/8 in. (3 mm)	1000 × 1000 mm (39 × 39 in.)	80	180018
Non-perforated (A-20)	White	3/16 in. (5 mm)	1000 × 1000 mm (39 × 39 in.)	48	180034
Non-perforated (A-20)	White	5/16 in. (8 mm)	1000 × 1000 mm (39 × 39 in.)	30	180042
Non-perforated (A-20)	White	3/8 in. (10 mm)	1000 × 1000 mm (39 × 39 in.)	24	180067
Non-perforated (A-20)	White	1/2 in. (13 mm)	1000 × 1000 mm (39 × 39 in.)	18	180083
Non-perforated (A-20)	Tan	1/8 in. (3 mm)	1000 × 1000 mm (39 × 39 in.)	80	188003
Non-perforated (A-20)	Tan	3/16 in. (5 mm)	1000 × 1000 mm (39 × 39 in.)	48	188011
Non-perforated (A-20)	Beige	1/8 in. (3 mm)	1000 × 1000 mm (39 × 39 in.)	80	189001
Non-perforated (A-20)	Beige	3/16 in. (5 mm)	1000 × 1000 mm (39 × 39 in.)	48	189009
Perforated (A-20)	White	1/8 in. (3 mm)	1000 × 1000 mm (39 × 39 in.)	80	181008
Perforated (A-20)	White	3/16 in. (5 mm)	1000 × 1000 mm (39 × 39 in.)	48	181024
Ventilated (A-20)	White	1/8 in. (3 mm)	1000 × 1000 mm (39 × 39 in.)	80	182006
Ventilated (A-20)	White	3/16 in. (5 mm)	1000 × 1000 mm (39 × 39 in.)	48	182014
Laminated PVC (A-20)	White	1/8 in. (3 mm)	1000 × 1000 mm (39 × 39 in.)	46	186974

Pe-Lite®

Medium Density Pe-Lite

Description	Color	Thickness	Size	Sheets per Case	Product Number
Non-perforated (A-8)	White	1/8 in. (3 mm)	1000 × 1000 cm (39 × 39 in.)	170	183004
Non-perforated (A-8)	White	3/16 in. (5 mm)	1000 × 1000 cm (39 × 39 in.)	100	183012
Non-perforated (A-8)	White	5/16 in. (8 mm)	1000 × 1000 cm (39 × 39 in.)	62	183020
Non-perforated (A-8)	White	3/8 in. (10 mm)	1000 × 1000 cm (39 × 39 in.)	50	183038
Non-perforated (A-8)	White	1/2 in. (13 mm)	1000 × 1000 cm (39 × 39 in.)	38	183046
Non-perforated (A-8)	Yellow	3/16 in. (5 mm)	1000 × 1000 cm (39 × 39 in.)	100	183034Y
Perforated (A-8)	White	1/8 in. (3 mm)	1000 × 1000 cm (39 × 39 in.)	170	184010
Perforated (A-8)	White	3/16 in. (5 mm)	1000 × 1000 cm (39 × 39 in.)	100	184002
Ventilated (A-8)	White	1/8 in. (3 mm)	1000 × 1000 cm (39 × 39 in.)	170	185009
Ventilated (A-8)	White	3/16 in. (5 mm)	1000 × 1000 cm (39 × 39 in.)	100	185017

Soft Density Pe-Lite

Description	Color	Thickness	Size	Sheets per Case	Product Number
Non-perforated (B-4)	White	1/8 in. (3 mm)	1000 × 1000 cm (39 × 39 in.)	170	186007
Non-perforated (B-4)	White	3/16 in. (5 mm)	1000 × 1000 cm (39 × 39 in.)	100	186015
Non-perforated (B-4)	White	5/16 in. (8 mm)	1000 × 1000 cm (39 × 39 in.)	62	186023
Non-perforated (B-4)	White	3/8 in. (10 mm)	1000 × 1000 cm (39 × 39 in.)	50	186031
Non-perforated (B-4)	White	1/2 in. (13 mm)	1000 × 1000 cm (39 × 39 in.)	39	186049
Ventilated (B-4)	White	3/16 in. (5 mm)	1000 × 1000 cm (39 × 39 in.)	100	186502

Volara

Ordering Information

Thickness	Material	Size	Product Number
1/8 in. (3 mm)	Volara	30 × 40 in. (76 × 102 cm) Sheet	169624
1/8 in. (3 mm)	Volara	30 × 100 in. (76 × 254 cm) Roll	169602
3/16 in. (5 mm)	Volara	30 × 40 in. (76 × 102 cm) Sheet	169626
3/16 in. (5 mm)	Volara	30 × 100 in. (76 × 254 cm) Roll	169608
1/4 in. (6 mm)	Volara	30 × 40 in. (76 × 102 cm) Sheet	169628
1/4 in. (6 mm)	Volara	30 × 100 in. (76 × 254 cm) Roll	169612
1/8 in. (3 mm)	Ventilated Volara	30 × 40 in. (76 × 102 cm) Sheet	169630
1/8 in. (3 mm)	Ventilated Volara	30 × 100 in. (76 × 254 cm) Roll	169618
3/16 in. (5 mm)	Ventilated Volara	30 × 40 in. (76 × 102 cm) Sheet	169632
3/16 in. (5 mm)	Ventilated Volara	30 × 100 in. (76 × 254 cm) Roll	169620
1/4 in. (6 mm)	Ventilated Volara	30 × 40 in. (76 × 102 cm) Sheet	169634
1/4 in. (6 mm)	Ventilated Volara	30 × 100 in. (76 × 254 cm) Roll	169622

Hook and Loop Fastener

Product Features

- Sold per roll (50 yards per roll)

Ordering Information

Plain Backed	White	Beige
5/8 in. Hook Fastener	212700	212700BG
5/8 in. Loop Fastener	212702	212702BG
3/4 in. Hook Fastener	212710	212710BG
3/4 in. Loop Fastener	212712	212712BG
1 in. Hook Fastener	212720	212720BG
1 in. Loop Fastener	212722	212722BG

Adhesive Backed	White	Beige
1 in. Hook Fastener	212760	212760BG
1 in. Loop Fastener	212762	212762BG
1 1/2 in. Hook Fastener	212770	212770BG
1 1/2 in. Loop Fastener	212772	212772BG
2 in. Hook Fastener	212780	212780BG
2 in. Loop Fastener	212782	212782BG

Velcro

Product Features

- Sold per roll (25 per pack)

Ordering Information

Plain Backed	White	Beige
1 in. Hook Velcro	213058	213116
1 in. Loop Velcro	213066	213124
1 1/2 in. Hook Velcro	213074	213132
1 1/2 in. Loop Velcro	213082	213140
2 in. Hook Velcro	213090	213157
2 in. Loop Velcro	213108	213165

Adhesive Backed	White	Beige
1 in. Adhesive Backed Velcro, Hook	213000	213009
1 in. Adhesive Backed Velcro, Loop	213001	213010
1 1/2 in. Adhesive Backed Velcro, Hook	213004	213013
1 1/2 in. Adhesive Backed Velcro, Loop	213003	213012
2 in. Adhesive Backed Velcro, Hook	213007	213016
2 in. Adhesive Backed Velcro, Loop	213006	-

Vinyl-Reinforced Velcro Straps

Product Features

- Prefabricated straps for finishing orthoses and prostheses
- Straps can be trimmed to size while still maintaining a neat finished end by cutting along the welded bars

Ordering Information

Size	A	B	C	D	White	Beige
1 × 10 in.	1 in.	4 in.	6 in.	2 Bars	213550	213600
1 × 14 ½ in.	1 in.	5 ½ in.	9 in.	2 Bars	213552	213608
1 ½ × 18 in.	1 ½ in.	4 in.	14 in.	2 Bars	213554	213616
1 ½ × 26 in.	1 ½ in.	6 in.	20 in.	2 Bars	213556	213624
1 ½ × 29 in.	1 ½ in.	8 in.	23 in.	2 Bars	213558	213632
2 × 18 in.	2 in.	5 in.	13 in.	2 Bars	213559	213636
2 × 26 in.	2 in.	6 in.	20 in.	2 Bars	213560	213640
2 × 34 in.	2 in.	8 in.	26 in.	2 Bars	213562	213648

Cleani-Stump Antiseptic Wipe

Product Features

- Developed for use on the sensitive skin of residual limbs and can also be used to disinfect the inside of sockets
- Contains an effective alcohol and lactic acid antiseptic which reduce the amount of bacteria and some viruses on the skin for up to 16 hours
- In addition to the anti-bacterial ingredients found in Cleani-Stump, a special emollient has been added to smooth and protect skin, helping to prevent irritation in sensitive areas



Ordering Information

Description	Product Number
Cleani-Stump Antiseptic Wipe case (case of 40 consumer boxes, 2000 total pieces)	631020000
Cleani-Stump Antiseptic Wipe (1 consumer box, 50 wipes pieces)	631020001

Isolation Bags

Product Features

- The isolation bags are made of high quality natural latex rubber with a stretchability of 700%



Ordering Information

Description	Product Number
X-small, 1.9 × 6.3 in. (50 × 160 mm), 10 per package	615100500
Small, 3.1 × 10.6 in. (80 × 270 mm), 10 per package	615100400
Medium, 3.3 × 11 in. (85 × 280 mm), 10 per package	615100300
Large, 4.3 × 12.2 in. (110 × 310 mm), 10 per package	615100200
X-large, 4.9 × 13.8 in. (125 × 350 mm), 10 per package	615100100
XX-large, 5.5 × 15.7 in. (140 × 400 mm), 10 per package	615100050

PolyCar-C Sheets

Product Features

- High performance reinforcing composite
- Easy to mold
- High carbon content
- Thermobonds to polypropylene, copolymer, and metal

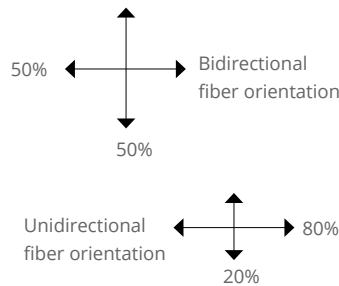

Ordering Information

Description	Product Number
12 × 12 × 0.06 in. (300 × 300 × 1.5 mm), Bidirectional Fiber Orientation	076608
12 × 24 × 0.06 in. (300 × 600 × 1.5 mm), Bidirectional Fiber Orientation	076610
12 × 12 × 0.09 in. (300 × 300 × 2.3 mm), Bidirectional Fiber Orientation	076612
12 × 24 × 0.09 in. (300 × 600 × 2.3 mm), Bidirectional Fiber Orientation	076614
12 × 12 × 0.125 in. (300 × 300 × 3 mm), Bidirectional Fiber Orientation	076616
12 × 24 × 0.125 in. (300 × 600 × 3 mm), Bidirectional Fiber Orientation	076618
12 × 18 × 0.125 in. (300 × 450 × 3 mm), Unidirectional Fiber Orientation	076620
12 × 36 × 0.125 in. (300 × 900 × 3 mm), Unidirectional Fiber Orientation	076622

Dacron Tape

Product Features

- Durable tape has “web” type construction to prevent stretching
- 25 yd. (22.5 m) per role
- Available in white, black, and beige



Ordering Information

Description	Width	White	Beige	Black
Dacron Tape	0.5 in. (13 mm)	212167	212242	212243
Dacron Tape	0.75 in. (19 mm)	212183	212252	-
Dacron Tape	1 in. (25 mm)	212209	212245	212246
Dacron Tape	1.5 in. (38 mm)	212225	212247	212248
Dacron Tape	2 in. (51 mm)	212241	212249	212250

Casting Socks

Ordering Information

- Sold per dozen

Description	Product Number
Heavy Cast Socks	168HJ
Light Cast Socks	168LJ
Disposable Boxer Cast Shorts, 100 per case	574960
Casting Balloon, Large, 25 pack	199076
Casting Balloon, Medium, 25 pack	199084
Casting Balloon, Small, 10 pack	199092

Transfer Paper

Product Features

- Different transfer papers available for different products
- 30 in. x 5 yd. (76 x 460 cm) per roll

Ordering Information

Description	Product Number
A. Butterflies 30 in. x 5 yd.	999101
B. Jungle Animals 30 in. x 5 yd.	999102
C. Camouflage 30 in. x 5 yd.	999103
D. USA Flag 30 in. x 5 yd.	999022
E. Planes, Cars, and Trucks 30 in. x 5 yd.	999125
F. Leopard 30 in. x 5 yd.	999120
G. Solid Blue	999021

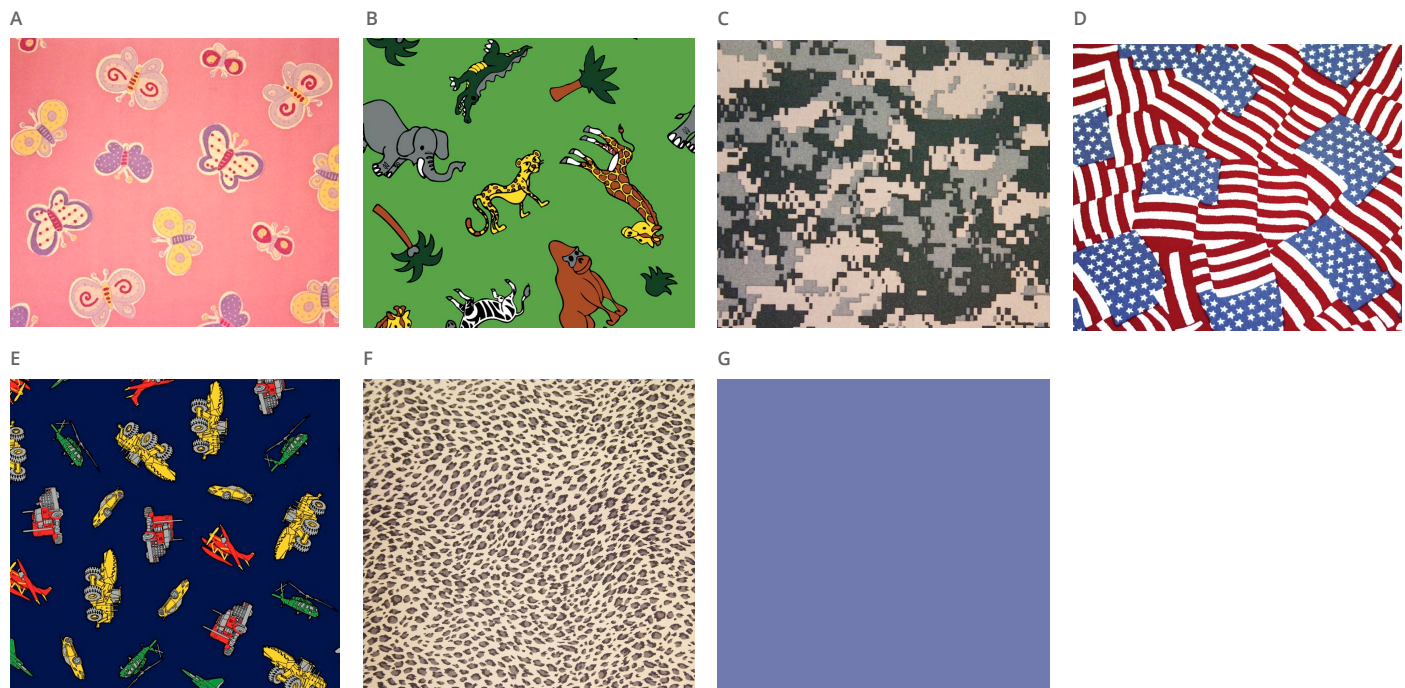

Thermoformable Composite (TFC) Sheets

Product Features

- Unidirectional—maximal strength in one direction and are good for bars, insoles, and strengthening
- Bi-directional—the same strength from 0° and 90° direction and good for difficult shapes like the heel
- Sheet size: 39.4 × 23.6 in. (1000 × 600 mm)



Ordering Information

COMFIL® Thermoformable Composite unidirectional

Description	Usage	Thickness	Product Number
Unidirectional Carbon	Bars and other rigid parts	0.08 in. (1.6 mm)	700010101
Unidirectional Carbon & Glassfiber	Bars and rigid insole	0.1 in. (2.55 mm)	700010103
Unidirectional Carbon	Reinforcements	0.03 in. (0.7 mm)	700010126

COMFIL® Thermoformable Composite Bidirectional

Description	Usage	Thickness	Product Number
Bi-directional Glassfiber	Opening flaps	0.03 in. (0.75 mm)	700010121
Bi-directional Glassfiber	Flexible toe off parts	0.06 in. (1.5 mm)	700010122
Bi-directional Glass-and Carbonfiber	Rigid foot plates	0.06 in. (1.5 mm)	700010123
Bi-directional Carbonfiber	Difficult shapes and strengthening	0.03 in. (0.7 mm)	700010124
Bi-directional Glass-and Carbonfiber	Rigid foot plates	0.07 in. (1.9 mm)	700010125
Bi-directional Carbonfiber	Difficult shapes and strengthening	0.02 in. (0.5 mm)	700010127
Bi-directional Liquid Crystal Polymer (LCP)	Increased flexibility	0.02 in. (0.6 mm)	700010135

For technical information about Thermoformable Composite material, please contact Fillauer

Thermoformable Composite (TFC) Insole

Product Features

- Flexible insoles are 0.06 in. (1.5 mm) thick and are better for shaping double curves, for example around the heel
- Rigid insole is 0.1 in. (2.5 mm) thick and made to be used as a rolling insole for diabetic patients
- Sold in pairs



Ordering Information

COMFIL® Insole Flexible

	Europe	USA	Product Number
Size	35 – 37	3.5 – 5	700030121
Size	38 – 40	6 – 7.5	700030122
Size	41 – 43	8 – 9	700030123
Size	44 – 46	10.5 – 12	700030124

COMFIL® Insole Rigid

	Europe	USA	Product Number
Size	35 – 37	3.5 – 5	700030141
Size	38 – 40	6 – 7.5	700030142
Size	41 – 43	8 – 9	700030143
Size	44 – 46	10.5 – 12	700030144

Bars

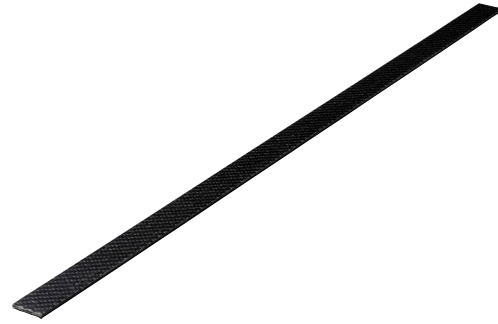

Ordering Information

Description	Dimensions	THICKNESS	Product Number
Unidirectional, Carbon & Glass Fiber	23.6 × 0.8 in. (600 × 20 mm)	0.1 in. (2.55 mm)	700020321

TFC Upright Bars & Silicone Forming Sleeve

Product Features

- Stronger and lighter than conventional metal uprights
- Thermoformable contouring using heat gun or oven
- Accommodates smaller radii bends
- Increased stiffness and flexibility of carbon composite
- Will not corrode unlike conventional metal uprights
- Uses innovative post pre-preg carbon material
- Optimized attachment plates for conventional metal joints
- Half oval



Ordering Information

Description	Size	Product Number
TFC Composite Upright	¾ × 18.5 in. (19 × 470 mm)	700600
TFC Composite Upright	⅝ × 18.2 in. (16 × 460 mm)	700601
Silicone Forming Sleeve	¾ × 18.5 in. (19 × 470 mm)	700610
Silicone Forming Sleeve	⅝ × 18.2 in. (16 × 460 mm)	700611
Flattening Plate For TFC Upright ¾ in. Bar		700620
Flattening Plate For TFC Upright ⅝ in. Bar		700621
Flattening Plate For TFC Upright ¾ in. Bar Offset Joint		700622

Teflon Sheet

Product Features

- Cover in the oven when heating material up

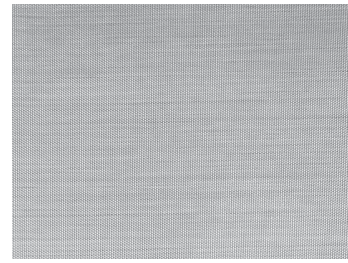

Ordering Information

Description	Dimensions	Thickness	Product Number
Teflon Sheet	40 × 40 in. (100 × 100 cm)	0.01 in. (0.25 mm)	70000010

Silicone Sheet



Ordering Information

Description	Dimensions	Thickness	Product Number
Silicone Sheet, Transparent, High Gloss	36.2 × 36.2 in. (92 × 92 cm)	0.03 in. (0.8 mm)	600320

Index by Description

A

Accessory Holder for Bench Carver	18
Accessory Holder for Floor Carver	15
Adapters	19, 36
Adjustable Mold Stand	43
Adjustable PVA Bag Pattern	62
Air Attachment for Floor Carver	15
Alignment Fixture	50
Alignment Tool	51
Antiseptic Wipe	69
AP-ML Gauge	60
Arbor	10
Arbors	20, 22, 23, 24, 25, 26

B

Bags	70
Bar Contouring Device	48
Bars	75
Bench Carver	17
Bench Carver Floor Stand	18
Bench Receptacle	51
Benchtop Infrared Oven	38
Bench Vise	49
Bender	51
Bending Irons	52
Blades	19
Bowls	62
BT-1 Benchtop Infrared Oven	38
BT-4 Infrared Oven	39
Bubble Forming Frames	42

C

Cable Swaging Tool	49
Carver	12, 13, 17
Cast Cutter	58
Casting Fixture Gauge	61
Casting Socks	71
Cast Mandrels	59
Cast Spreaders	58
Clamps	53
Cleani-Stump Antiseptic Wipe	69
Coneiak Polishing Arbors	20
Cones	27
Consolidation Stand	36
Contouring Device	48
Contouring Fork and Bench Receptacle	51

Contouring Irons	52
Control Assembly	35
Cutters	19, 57, 58
Cutting Tool for 30 mm Carbon Fiber Tube	57

D

Dacron Tape	71
Deburring Tool	57
Double Drum Sander	11
Drape Forming Adapters	36
Drill Attachments ½-13 Thread	19
Drill Press Fixture	50
Drum	28
Dual Purpose Expansion Arbors	22
Dust Collection Hose Kit for 2100L	14
Dust Collector Attachment for Floor Carver	14
Dust Collector for Bench Carver	18

E

Electric Sealer	55
Electronic Scale	63
Expansion Arbors	22, 23

F

Fan Kit	42
Fastener	68
Felt Arbors	24, 25
Files	59
Fixture	46, 47, 48, 50
Fixture Gauge	61
Floor Carver	12, 13
Floor Stand	18
Foam Arbors	26
Foam Shaper	26
Foot Switch for 115 V Carvers	16
Forming Sleeve	75
Frames	34, 42

G

Gauge	60, 61
Gloves	44, 63
Goniometer	61
Grinding Rasps	29

H

Hand Roller	63
Heat Gun	55
Heavy-Duty Retractable Utility Knife	56
Holding Frames	34
Hook and Loop Fastener	68
Hot Mill Gloves	63

I

Insole	74
Irons	52
Isolation Bags	70

J

Joint Alignment Tool	51
----------------------------	----

K

Knife	56
-------------	----

L

Laminating Fixture LJ-100	46
Lift Assist Kit for Floor Carver	16
LJ-100	46

M

Mandrels	59
Measuring Tapes	59
Mixing Bowls	62
Mobile Vacuum Unit	32
Mold Library	43
Mold Stand	43

O

Original AP-ML Gauge	60
Oven Fan Kit	42

P

PDQ BT-1 Benchtap Infrared Oven	38
PDQ BT-4 Infrared Oven	39
PDQ Bubble Forming Frames	42
PDQ Mold Library	43
PDQ Oven Fan Kit	42
PDQ Oven Gloves	44
PDQ Plastic Rack	43
PDQ PO-2 Infrared Oven	41
PDQ Rollabout Oven	40
Pe-Lite®	66, 67

Pipe Holding Fixtures	48
Plastic Rack	43
Pneumatic Cast Cutter	58
Pneumatic Sand Drum	28
PO-2 Infrared Oven	41
Polishing Arbors	20, 25
PolyCar-C Sheets	70
Portable Oilless Vacuum Pump	35
Prosthetic Bench Vise	49
Punch	54
PVA Bag Pattern	62
PVA Electric Sealer	55

R

Rack	43
Rasps	29
Replacement Blades	19
Revolving Punch	54
Rivet Bar	52
Rivet Gauge	60
Rollabout Oven	40
Rounded Blade Spatula	62
Router Adapters	19
Rubber Mixing Bowls	62
Rubber Sand Cones	27
Ruler and Rivet Gauge	60

S

Sand Cones	27
Sand Drum	28
Sander	11
Scale	63
Scalpel	56
Scarpas Knife	56
Scissors	54
Sealer	55
Shaft Foam Arbors	26
Shaper	26
Sheets	70, 73, 76
Silicone Forming Sleeve	75
Silicone Hand Roller	63
Silicone Sheet	76
Single Speed Bench Carver	17
Single Speed Floor Carver	12
Sleeve	75
Socks	71
Soft Foam Shaper	26
Spatula	62
Spreaders	58
Spring Clamps	53
Stand	43

Steinel® Heat Gun	55	Vertical Fabricating Fixture, VFJ-100.....	47
Stirrup Bender	51	VFJ-100	47
Straps	69	Vinyl-Reinforced Velcro Straps	69
Surform™ Files	59	Vise	49
Surgical Scalpel	56	Volara	67
Surgical Tubing	46		
Swaging Tool	49	W	
		Wipe	69
T		Y	
Tape	71	Yates Clamps.....	53
Tapered Felt Arbor / Core	24		
Tapes	59		
Tech Station.....	33		
Teflon Sheet	76		
TFC Consolidation Stand	36		
TFC Upright Bars & Silicone Forming Sleeve	75		
Thermoformable Composite (TFC) Insole.....	74		
Thermoformable Composite (TFC) Sheets	73		
Tongue Tray.....	44		
Transfemoral Length Gauge.....	61		
Transfer Paper	72		
Transtibial Length Gauge	60		
Trautman Arbor 5001	10		
Trautman Coneiak Polishing Arbors	20		
Trautman Double Drum Sander.....	11		
Trautman Single Speed Bench Carver.....	17		
Trautman Single Speed Floor Carver.....	12		
Trautman Tech Station	33		
Trautman Vacuum Stations	34		
Trautman Variable Speed Bench Carver.....	17		
Trautman Variable Speed Floor Carver.....	13		
Tray.....	44		
Tube Cutter	57		
Tubing	46		
Tycro Polishing Arbors.....	25		
U			
Universal Alignment Fixture	50		
Universal AP-ML Gauge	60		
Urethane Arbors.....	25		
Utility Knife	56		
V			
Vacuum Control Assembly	35		
Vacuum Pump.....	35		
Vacuum Stations.....	34		
Vacuum Unit	32		
Variable Speed Bench Carver	17		
Variable Speed Floor Carver	13		
Velcro	68		
Velcro Straps	69		

Index by Part Number

5-514.....	54	5001-3	10	169632.....	67
5-516.....	54	5001-3-50.....	10	169634.....	67
5-550.....	54	5005-1	11	180018.....	66
5-568.....	54	5005-1-50.....	11	180034.....	66
10-099	56	5005-3	11	180042.....	66
11-921	56	5005-3-50.....	11	180067.....	66
21-291	59	34870	55	180083.....	66
21-293	59	40010	52	181008.....	66
21-295	59	50520	49	181024.....	66
21-297	59	50522.....	49	182006.....	66
21-299	59	50523.....	49	182014.....	66
21-399	59	50524.....	49	183004.....	67
155	54	51273	46	183012.....	67
168HJ	71	51275	46	183020.....	67
168LJ.....	71	51391	26	183034Y.....	67
2100/50	12	51454	46	183038.....	67
2100/60	12	51455	46	183046.....	67
2100B.....	19	51459.....	46	184002.....	67
2100BB.....	19	51779.....	62	184010.....	67
2100C.....	27	51831	53	185009.....	67
2100D.....	27	51848	61	185017.....	67
2100E.....	29	52056.....	47	186007.....	67
2100F.....	28	52115.....	53	186015.....	67
2100G.....	28	52116.....	53	186023.....	67
2100H.....	19	52872.....	53	186031.....	67
2100HB.....	19	54795.....	52	186049.....	67
2100J.....	15	58188.....	47	186502.....	67
2100K.....	16	58633.....	47	186974.....	66
2100L.....	14	58640.....	47	187005.....	66
2100LA.....	12	58641.....	47	187013.....	66
2100LA.....	13	60739.....	57	187495.....	66
2100LA.....	16	61714.....	47	187500.....	66
2100P.....	27	076608.....	70	188003.....	66
2100R.....	19	076610.....	70	188011.....	66
2100S.....	19	076612.....	70	189001.....	66
2100X.....	26	076614.....	70	189009.....	66
2300/50	13	076616.....	70	199076.....	71
2300/60	13	076618.....	70	199084.....	71
2300M	12	076620.....	70	199092.....	71
2300M	13	076622.....	70	212167.....	71
2300M	15	169602.....	67	212183.....	71
2500/50	17	169608.....	67	212209.....	71
2500/60	17	169612.....	67	212225.....	71
2500L.....	18	169618.....	67	212241.....	71
2500M.....	18	169620.....	67	212242.....	71
2500X.....	26	169622.....	67	212243.....	71
2600/50	17	169624.....	67	212245.....	71
2600/60	17	169626.....	67	212246.....	71
5001-1	10	169628.....	67	212247.....	71
5001-1-50.....	10	169630.....	67	212248.....	71

212249	71	220133	48	225117	27
212250	71	220135	48	225118	27
212252	71	220137	61	225119	27
212700BG	68	220145	60	225136	24
212702BG	68	220160	50	225141	24
212710BG	68	220162	50	225151	24
212712BG	68	220164	50	225169	24
212720BG	68	220178	49	225171	24
212722BG	68	220186	51	225173	24
212760BG	68	220194	51	225175	24
212762BG	68	220202	51	225177	24
212770BG	68	220210	51	225185	11
212772BG	68	220285	52	225194	11
212780BG	68	220293	51	225230	26
212782BG	68	220301	49	225232	26
213058	68	220310	57	225234	26
213066	68	220311	57	225240	26
213074	68	220312	57	225242	26
213082	68	220321	57	225244	26
213090	68	220327	60	225247	10
213108	68	220328	59	225248	10
213116	68	220329	59	225249	10
213124	68	220331	59	225252	29
213132	68	220335	60	225256	29
213140	68	220336	60	225262	29
213157	68	220355	61	225266	29
213165	68	220460	56	225320	22
213550	69	220461	56	225320MM	22
213552	69	224100	28	225325	22
213554	69	224101	28	225330	22
213556	69	224102	28	225330MM	22
213558	69	224103	28	225335	22
213559	69	225011	19	225340	22
213560	69	225016	19	225345	22
213562	69	225017	19	225350	23
213600	69	225029	19	225350MM	23
213608	69	225037	29	225352	23
213616	69	225045	29	225352MM	23
213624	69	225052	29	225354	23
213632	69	225060	29	225354MM	23
213636	69	225068	24	225360	23
213640	69	225070	24	225362	23
213648	69	225072	24	225364	23
220020	51	225080	25	225380	23
220038	51	225082	25	225380MM	23
220059	62	225090	25	225385	23
220063	62	225100	25	225400	20
220103	48	225110	25	225400MM	20
220111	48	225111	27	225405	20
220115	48	225112	27	225410	20
220128	50	225114	27	225410MM	20
220129	48	225115	27	225415	20
220131	48	225116	27	225420	21

225420MM.....	21	227495.....	36	700010101.....	73
225425.....	21	227497.....	36	700010103.....	73
225430.....	20	227500.....	35	700010121.....	73
225430MM.....	20	227594.....	53	700010122.....	73
225435.....	20	227728.....	34	700010123.....	73
225440.....	20	227729.....	34	700010124.....	73
225440MM.....	20	227730.....	34	700010125.....	73
225445.....	20	227751.....	34	700010126.....	73
225450.....	20	227752.....	34	700010127.....	73
225450MM.....	20	259050.....	59	700010135.....	73
225455.....	20	259053.....	59	700020321.....	75
225460.....	21	259056.....	59	700030121.....	74
225460MM.....	21	259060.....	59	700030122.....	74
225465.....	21	390190.....	18	700030123.....	74
225490.....	20	390900.....	12	700030124.....	74
225490MM.....	20	390900.....	13	700030141.....	74
225495.....	20	395012.....	33	700030142.....	74
225520.....	25	395050.....	33	700030143.....	74
225600.....	21	395250.....	33	700030144.....	74
225605.....	21	395400.....	33	731000125.....	57
225610.....	21	395550.....	33	A24.....	10
225615.....	21	395810.....	33	BFF-9-BT3.....	42
225620.....	21	574960.....	71	BFF-9-BT4.....	42
225650.....	21	600320.....	76	BFF-12-BT3.....	42
226005.....	14	600350.....	54	BFF-12-BT4.....	42
226050.....	62	600355.....	63	BFF-16-BT3.....	42
226142.....	55	600360.....	55	BFF-16-BT4.....	42
226159.....	55	600500.....	36	BFF-18-BT3.....	42
226167.....	55	700600.....	75	BFF-18-BT4.....	42
226175.....	55	700601.....	75	BFF-24-BT3.....	42
226220.....	58	700610.....	75	BFF-24-BT4.....	42
226226.....	58	700611.....	75	C24.....	22
226228.....	58	700620.....	75	C24.....	23
226258.....	58	700621.....	75	C24.....	27
226258.....	58	700622.....	75	C80.....	22
226262.....	58	800050.....	56	C80.....	23
227005.....	35	800060.....	56	C80.....	27
227006.....	35	999021.....	72	C120.....	22
227008.....	63	999022.....	72	C120.....	23
227020.....	35	999101.....	72	C120.....	27
227021.....	35	999102.....	72	C180.....	22
227100.....	63	999103.....	72	C180.....	23
227305.....	32	999120.....	72	C180.....	27
227347.....	33	999125.....	72	C240.....	22
227347.....	36	615100050.....	70	C240.....	23
227354.....	33	615100100.....	70	C240.....	27
227354.....	36	615100200.....	70	C320.....	22
227420.....	34	615100300.....	70	C320.....	23
227438.....	34	615100400.....	70	C320.....	27
227443.....	34	615100500.....	70	D24.....	22
227449.....	34	631020000.....	69	D24.....	23
227450.....	34	631020001.....	69	D24.....	27
227451.....	34	700000010.....	76	D80.....	22

D80	23
D80	27
D120	22
D120	23
D120	27
E-100	57
F60	28
F120	28
G60	28
G120	28
O 5A-INT	40
O 6B-INT	40
O 7C-INT	40
O 8E-INT	40
OFANKIT	42
OFANNEW	42
OMOLDSTAND	43
P50	23
P50	27
P100	23
P100	27
P180	23
P180	27
PDQ-5A	40
PDQ-6B	40
PDQ-7C	40
PDQ-8E	40
PDQ-BF-9	42
PDQ-BF-12	42
PDQ-BF-16	42
PDQ-BF-18	42
PDQ-BF-24	42
PDQ-BT-1	38
PDQ-BT-4	39
PDQ-MOLDLIBRARY	43
PDQ-ORSUP-GLOVES	44
PDQ-PO-2	41
RACKLARGE	43
RACKSMALL	43
S24	10
S24	11
S50	10
S50	11
S120	10
S120	11
S180	10
S180	11
S240	10
S240	11
TONGUE-TRAY	44