

# Tools, Equipment & Materials





# Fillauer®

In 1914, George Fillauer Sr. founded the Red Star Pharmacy in Chattanooga, Tennessee. In 1934, his son and fellow CPO, Carlton Fillauer expanded his father's business to establish Fillauer Orthopedic as an innovator in the orthotics and prosthetics industry. Today, the Fillauer Companies are headed by Karl Fillauer as Chairman and his son Michael as the CEO, since their inception, the Fillauer Companies have always been headed by CPO's, and have grown to be a globally renowned leader in the development, manufacturing, distribution and application of orthotic and prosthetic products. The expansion has mainly taken place by acquisitions of smaller manufacturing companies with a unique profile. Over the years we have become nine companies under the Fillauer umbrella and during the 100 year celebration in 2014 a decision was taken on how the company would be steered into the next century. Therefore a consolidation took place in 2015 where all the companies became Fillauer.

Fillauer Europe was founded as Centri in 1948. Located just outside Stockholm, Sweden, Centri joined the Fillauer Companies 2002. While Centri maintained the close, cooperative relationships it traditionally had with prosthetists in Scandinavia, as Fillauer Europe it has now become the European headquarters of Fillauer. With its extensive portfolio of products, Fillauer Europe is committed to working with prosthetists both in Europe, but also in other regions of the world in order to create only the best solutions for patients with all manner of prosthetic and orthotic needs. In addition, Fillauer Europe plays a lead Research & Development role within Fillauer. Fillauer Europe's products include upper and lower extremity prosthetics and the Dynamic Walk which has catapulted us to the forefront of the drop foot orthotics market. Our R&D department also works in partnership with many of Sweden's leading hospitals to develop innovative and high-tech machinery.



# Index

Fillauer Product Warranty	6
Returns, Adjustments, and Credits	7
Catalog symbol legend	8

## Trautman Carvers & Sanders

Trautman Arbor 5001	10
Trautman Double Drum Sander	11
Trautman Variable Speed Floor Carver	12
Trautman Single Speed Floor Carver	13
Trautman Tech Station	14
Dust Collector for Floor Carver	15
Dust Collection Hose Kit for 2100L	15
Air Attachment for Floor Carver	16
Accessory Holder for Floor Carver	16
Lift Assist Kit for Floor Carver	17
Trautman Variable Speed Bench Carver	18
Trautman Single Speed Bench Carver	18
Bench Carver Floor Stand	19
Accessory Holder for Bench Carver	19
Dust Collector for Bench Carver	19
Drill Attachments 1/2"-13 Thread	20
Cutters & Replacement Blades	20
Soft Foam Shaper	21
Shaft Foam Arbors	21
Urethane and Felt Arbors	22
Pneumatic Sand Drum	22
Sand Drum	23
Rubber Sand Cones	24
Tapered Felt Arbor/ Core	25
Expansion Arbors	26
Dual Purpose Expansion Arbors	27
Grinding Rasps	28
Router Adapters	28
Tycro Polishing Arbor	29
Trautman Coneiak Polishing Arbors	30

## Trautman Vacuum Systems

Mobile Vacuum Unit	33
Vacuum Control Assembly	34
Portable Oilless Vacuum Pump	34
Holding Frames	35

Drape Forming Adapters	35
Trautman Vacuum Stations	36

## PDQ Ovens

PDQ Rollabout Oven	38
PDQ BT-1 Benchtop Infrared Oven	39
PDQ BT-4 Infrared Oven	40
PDQ PO-2 Infrared Oven	41
PDQ Oven Fan Kit	42
Tongue Tray	42
PDQ Oven Gloves	42

## Fabrication Equipment

Laminating Fixture LJ-100	44
Surgical Tubing	44
Vertical Fabricating Fixture, VFJ-100	45
Bar Contouring Device	46
Pipe Holding Fixtures	46
Prosthetic Bench Vise	47
Cable Swaging Tool	47
Drill Press Fixture	48
Universal Alignment Fixture	48
Stirrup Bender	48
Contouring Fork and Bench Receptacle	49
Joint Alignment Tool	49
Bending Irons	50
Contouring Irons	50
Spring Clamps	51
Yates Clamp	51
Scissors	51
Hex Screwdriver	52
Hex Keys	52
Torque Screwdriver	52
Torque Wrench	52
Scarpas Knife	53
Surgical Scalpel	53
Pin Wrench	53
Deburring Tool	54
Tube Cutter	54
Cutting Tool for 30 mm Tubes	54
Cast Cutter	55

Measuring Tapes	56	Teflon Sheet	76
Cast Mandrels		Silicone Sheet	77
	56	Vacuum Bag material	77
Surform™ Files		Tape	77
	56	Silicone Glove	78
Transtibial Length Gauge	57	Release Film - sheet	78
Original AP-ML Gauge	57	Silicone Bag	78
Universal AP-ML Gauge	57		
Transfemoral Length Gauge	58		
Goniometer	58		
Casting Fixture Gauge	58		
Rounded Blade Spatula			
	59		
Hot Mill Gloves	59		

## Materials

Censoft	61
Cenpol	61
Thermo Foam 4E/ Firm Foam	62
Durrplex	62
Polypropylene	63
Thermoflex	64
Thermoflex with Silicone	64
Cleani-Stump Antiseptic Wipe	65
Isolation Bags	65
PVA Bags and Film	66
Alginate Impression Powder	66
PolyCar-C Sheets	67
Silicone	67
Transforming Silicone Putty	68
Carbon Fiber Band	68
Polyester Stockinette - Lamination Tube	69
Elastic Stockinette Tube, 12.5% Lycra	69
Elastic Stockinette Tube, 7% Lycra	70
Cotton Stockinette	70
Dacron Tape	71
Casting Socks	71
Comfort Casting Socks	71
Transfer Paper	72
Thermoformable Composite (TFC), Sheets	73
Thermoformable Composite (TFC), Insole	74
Bars	75
TFC Upright Bars & Silicone Forming Sleeve	75
Cotton Stockinette	76



# Fillauer Product Warranty

Fillauer items under warranty will be replaced or repaired (at Fillauer's discretion) at no charge, if the material or workmanship is found to be defective. Normal wear is not warranted. The warranty will be void if the item has been: a. fabricated or installed outside Fillauer's recommendations b. modified c. exposed to a corrosive environment d. if used outside of the products intended use. Below is a summary of warranties.

## ORTHOTIC, PROSTHETIC COMPONENTS AND EQUIPMENT

are warranted for 12 months from the date of shipment from the Fillauer warehouse or from an authorized Fillauer distributor with the following exceptions:

### SUSPENSION SLEEVES, SILICONE GLOVES, SPINAL BRACES & CUSTOM LINERS/SLEEVES

are warranted for 3 months from the date of shipment from the Fillauer warehouse or from an authorized Fillauer distributor.

Custom Fabrication Items, Prosthetic Liners, Dream Skin, Foot Shells, Cosmetic Gloves, Passive Hands and Trautman Tools & Accessories are warranted for 6 months from the date of shipment from the Fillauer warehouse or from an authorized Fillauer distributor.

## HOSMER HOOKS

are warranted for 18 months from the date of shipment from the Fillauer warehouse or from an authorized Fillauer distributor.

## ELBOWS

are warranted for 18 – 24 months from the date of shipment from the Fillauer warehouse or from an authorized Fillauer distributor. See specific product warranty for more information.

## FILLAUER FEET

are warranted for 12, 24, or 36 months

**12 months:** Running Blade

**24 months:** AllPro, K2, Motion Foot® MX, Formula and Raize

**36 months:** Aeris Activity, Aeris Performance 2, Aeris Performance LP, Element, Element DS, Ibex XD, and Wave Comfort 3

## COAPT & TASKA

Are warranted for 24 months from the date of shipment from the Fillauer warehouse or from an authorized Fillauer distributor.

**All warranties are voided by alteration or misuse of the product.**

## Returns, Adjustments, and Credits

Inspect all goods immediately upon receipt for damage or errors in shipping. Call Customer Service within 3 business days in the event of errors or damage. Credit will not be issued for custom items made to specification or non-stock items older than 30 days, unless Fillauer shipped in error or there is defect in materials or workmanship.

Prior approval and a return authorization number must be obtained from Customer Service for all goods returned. Credit for returned merchandise is subject to inspection and may be subject to a 15% restocking fee for merchandise in resalable condition. Goods returned without prior approval may be subject to a 25% restocking fee. No credit shall be issued for goods that are more than 12 months old. Returns must be returned in unopened sellable packaging accompanied by a copy of original invoice, order number, or PO number. The return authorization number, provided by Customer Service, must appear on the shipping label.



# Catalog symbol legend

## Specification symbols

- .....
- SE** Manufactured in Sweden
- .....
- US** Manufactured in USA
- .....
- ES** Manufactured in Spain
- .....

## Color symbols

- .....
-  CC03/Tan
- .....
-  CC99/Black
- .....
-  Grey
- .....
-  Green
- .....
-  Pink
- .....
-  Orange
- .....



# Trautman Carvers & Sanders

## Specification symbols

---

**SE** Manufactured in Sweden

---

**US** Manufactured in USA

---



# Trautman Arbor 5001

US

## Specifications

**Height:** 48 in. (122 cm)**Speed:** 1725 rpm**Width:** 47 in. (119 cm)**Thread:** 1/2"-13**Base plate:** 25 x 20 in. (635 x 508 mm)**Warranty:** 12 months from the date of shipment**Weight:** 560 lbs. (254 kg)

## Product Features

The 5001 Trautman Arbor has powerful Baldor 2 HP, 60 HZ, 1 phase 115/230 V or 230/460 V motor. It comes with a 14 in. (350 mm) disc and an 8 in. (200 mm) Pneumatic Sanding Drum.

- Dual drive belts
- 2 horse power, Baldor motor
- 1725 rpm at 60Hz
- Durable powder coated finish

## Ordering information

### TRAUTMAN ARBOR

DESCRIPTION	PRODUCT NUMBER
Trautman Arbor, Single Phase, 50Hz, 230 V	5001-1-50
Trautman Arbor, Three Phase, 50Hz, 460 V	5001-3-50

### SAND DISC

DESCRIPTION	PRODUCT NUMBER
Sand Disc, 24 Grit	A24

### SAND CONES FOR NON-PNEUMATIC DRUMS

DESCRIPTION	PRODUCT NUMBER
Sand Drum Sleeve, 24 Grit	S24
Sand Drum Sleeve, 50 Grit	S50
Sand Drum Sleeve, 120 Grit	S120
Sand Drum Sleeve, 180 Grit	S180
Sand Drum Sleeve, 240 Grit	S240

### SAND DRUM SLEEVES - PNEUMATIC

DESCRIPTION	PRODUCT NUMBER
Sand Drum Sleeve Fine-120 Grit	225247
Sand Drum Sleeve Fine-100 Grit	225248
Sand Drum Sleeve Coarse-36 Grit	225249

# Trautman Double Drum Sander

US

## Specifications

**Height:** 44 in. (112 cm)

**Width:** 45 in. (114 cm)

**Weight:** 535 lbs. (243 kg)

**Speed:** 1725 rpm

**Warranty:** 12 months from the date of shipment

## Product Features

The Trautman 5005 DD Sander comes with same motor, motor control, dual drive belts with guard and base as 5001 Arbor. This machine has two 9 in. (23 cm) Pneumatic Sanding Drums.

- Dual drive belts
- 2 horse power, Baldor® motor
- Durable powder coated finish

## Ordering information

### TRAUTMAN DOUBLE DRUM SANDER

DESCRIPTION	PRODUCT NUMBER
Trautman Arbor, Single Phase, 50Hz, 230 V	<b>5005-1-50</b>
Trautman Arbor, Three Phase, 50Hz, 460 V	<b>5005-3-50</b>

### SAND CONES FOR NON-PNEUMATIC DRUMS

DESCRIPTION	PRODUCT NUMBER
Sand Drum Sleeve, 24 Grit	<b>S24</b>
Sand Drum Sleeve, 50 Grit	<b>S50</b>
Sand Drum Sleeve, 120 Grit	<b>S120</b>
Sand Drum Sleeve, 180 Grit	<b>S180</b>
Sand Drum Sleeve, 240 Grit	<b>S240</b>

### SAND DRUM SLEEVES - PNEUMATIC

DESCRIPTION	PRODUCT NUMBER
Sand Drum Sleeve Fine-36 Grit	<b>225185</b>
Sand Drum Sleeve Fine-120 Grit	<b>225194</b>





# Trautman Variable Speed Floor Carver

**US**

## Specifications

**Height:** 63 in. (160 cm)

**Working Height:** 26 - 56 in. (66 - 142 cm)

**Weight:** 228 lbs. (103 kg)

**Speed:** 1380 - 3450 rpm, 115 V (1380 - 2860 rpm, 230 V)

**Thread:** 1/2"-13 or 5/8"-11

**Warranty:** 12 Months from the date of shipment

## Product Features

- Precise speed control for best results possible
- Heavy duty 3/4 hp Baldor® motor and controller
- Brushless motor for low maintenance
- Motor is thermally protected to prevent damage from overheating
- Factory lubricated and sealed bearings for long-lasting use
- Pre-attached 40 watt work light for the 60 Hz machine
- Fully adjustable height and tilt
- Torque overload safety feature
- Heavy duty base for stability



Floor Carver  
shown with  
Carver Lift Assist

## Ordering information

### TRAUTMAN VARIABLE SPEED FLOOR CARVER

DESCRIPTION	FREQUENCY	THREAD	PRODUCT NUMBER
Trautman Floor Carver	50 Hz, 230 V	1/2"-13	<b>2300/50</b>
Trautman Floor Carver	50 Hz, 230 V	1/2"-13	<b>2300/50</b>
Anchor Bolt System			<b>390900</b>
Lift assist holder			<b>2100LA</b>
Accessory Holder			<b>2300M</b>

# Trautman Single Speed Floor Carver

US

## Specifications

**Height:** 63 in. (160 cm)

**Working Height:** 26 - 56 in. (66 - 142 cm)

**Weight:** 219 lbs (99 kg)

**Speed:** 3450 rpm, 115 V (2860 rpm, 230 V)

**Thread:** 1/2"-13

**Warranty:** 12 Months from the date of shipment

## Product Features

- Durable 1/2 hp Baldor® Motor
- Brushless motor for low maintenance
- Motor is thermally protected to prevent damage from overheating
- Factory lubricated and sealed bearings for long-lasting use
- Pre-attached 40 watt work light for the 60 Hz machine
- Fully adjustable height and tilt
- Torque overload safety feature
- 5/8"-11 threaded accessories may be used with Trautman Router Adapter, PN 225029



Floor Carver  
shown with  
Carver Lift Assist

## Ordering information

### TRAUTMAN SINGLE SPEED FLOOR CARVER

DESCRIPTION	PRODUCT NUMBER
Trautman Floor Carver, Single Speed, 50 Hz, 230 V	<b>2100/50</b>
Anchor Bolt System	<b>390900</b>
Lift Assist Holder	<b>2100LA</b>
Accessory Holder	<b>2300M</b>



# Trautman Tech Station

**US**

## Specifications

Height: 70 in. (180 cm)

Width: 37 in. (94 cm)

Depth: 36 in. (91 cm)

\*Shipping Weight: 190 lbs (86 kg)

Warranty: 12 Months from the date of shipment

## Product Features

- State-of-the-art modular, multipurpose workstation
- Small footprint maximizes workspace
- 360-degree rotation with easy adjustments
- Base unit can be modified with various attachments and accessories for custom needs

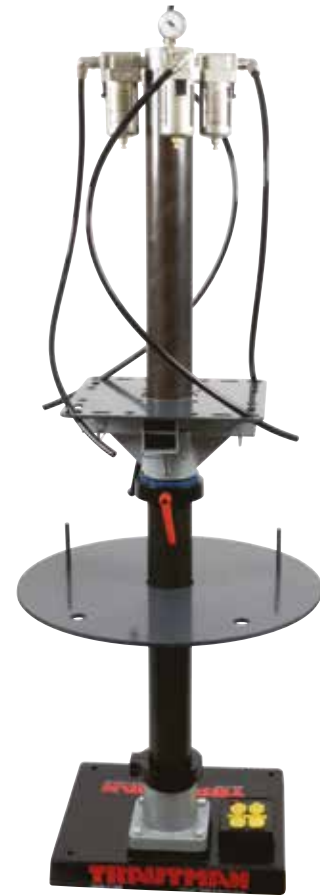

## Ordering information

### TRAUTMAN TECH STATION

DESCRIPTION	SHIPPING WEIGHT	PRODUCT NUMBER
Trautman Tech Station	86 kg	395400

### TRAUTMAN TECH STATION ATTACHMENTS

DESCRIPTION	SHIPPING WEIGHT	PRODUCT NUMBER
Trautman Tech Pipe Vise	4kg	395012
Trautman Tech Pipe Vise with Drop Hitch	6 kg	395250
Trautman Tech Drape Forming Pipe Holder	5 kg	395550
Trautman Tech Attachment for Bench Carver	3 kg	395050
Trautman 12 in. Platen	5 kg	227347
Trautman Tech LJ-100 Adapter	5 kg	395810

# Dust Collector for Floor Carver

US

## Product Features

- Infinitely adjustable
- Steel construction
- 4 in. (10 cm) exhaust for connection to vacuum system



## Ordering information

### DESCRIPTION

Dust Collector for Floor Carver

### PRODUCT NUMBER

**2100L**

# Dust Collection Hose Kit for 2100L

US

## Product Features

- For use with Dust Collector for Floor Carver (PN 2100L)
- 4 in. (10 cm) diameter clear hose for viewing any obstruction
- 6 ft. (1.8 m) of flexible hose reach
- 2 worm-drive clamps for connection
- Internal abrasion resistant
- Enclosed steel wire reinforced



## Ordering information

### DESCRIPTION

Dust Collection Hose Kit for 2100L

### PRODUCT NUMBER

**226005**



## Air Attachment for Floor Carver

US

### Product Features

The air attachment directs an adjustable air stream to blow dust and chips from the cutting tool and to assist in cooling down thermoplastic grinding for more efficient grinding. Standard 1/4 in. (0.6 cm) pipe fitting to be attached to your air supply.

- Features a flat air flow nozzle
- Flexible stay set hose for adjustable air stream



### Ordering information

**DESCRIPTION**

Air Attachment for Floor Carver

**PRODUCT NUMBER**

**2100J**

## Accessory Holder for Floor Carver

US

### Product Features

- Round, rotatable carousel design
- Keeps accessories organized, visible and accessible
- 23 total peg locations, includes 8 long and 23 short pegs for custom peg layouts

NOTE: Accessories not included



Accessories sold separately

### Ordering information

**DESCRIPTION**

Accessory Holder for Floor Carver

**PRODUCT NUMBER**

**2300M**



# Lift Assist Kit for Floor Carver

US

## Product Features

- Assists in both lifting and lowering
- Easy to install
- Provides over 16 in. (40 cm) of adjustment
- Works on all Trautman models, past and current
- Thrust bearing for ease of rotation
- Shock provides slam-resistant damping at the end of the stroke



## Ordering information

DESCRIPTION	PRODUCT NUMBER
Carver Lift Assist	2100LA



# Trautman Variable Speed Bench Carver

US

## Specifications

**Height:** 22 in. (56 cm)      **Speed:** 1380 - 3400 rpm, 115 V (1380 - 2820 rpm, 230 V)  
**Working Height:** 15 - 22 in. (38 - 56 cm)      **Thread:** 1/2"-13  
**Weight:** 28 lbs. (12.7 kg)      **Warranty:** 12 months from the date of shipment

## Product Features

- Maintenance-free 1/3 hp motor and controller
- High quality variable speed motor controller
- Lubricated ball bearings, sealed for life



## Ordering information

### TRAUTMAN ARBOR

DESCRIPTION	PRODUCT NUMBER
Trautman Bench Carver, Variable Speed, 50 Hz, 230 V, 1/2"-13 Thread	<b>2600/50</b>

# Trautman Single Speed Bench Carver

US

## Specifications

**Height:** 22 in. (56 cm)      **Speed:** 3400 rpm, 115 V (2820 rpm, 230 V)  
**Working Height:** 15 - 22 in. (38 - 56 cm)      **Thread:** 1/2"-13  
**Weight:** 25 lbs. (11.3 kg)      **Warranty:** 12 Months from the date of shipment

## Product Features

- Great for satellite offices or bench work
- Maintenance free 1/3 hp motor
- Lubricated sealed ball bearings
- 5/8-11 threaded accessories may be used with Trautman Router Adapter, PN 225029)



## Ordering information

### TRAUTMAN ARBOR

DESCRIPTION	PRODUCT NUMBER
Trautman Bench Carver, 50 Hz, 230 V, 1/2"-13 Thread	<b>2500/50</b>

# Bench Carver Floor Stand

US

## Product Features

- Adjustable height 35 – 56 in. (89 - 142 cm)
- Alloy screw adjusts clamping force

## Ordering information

DESCRIPTION	PRODUCT NUMBER
Bench Carver Floor Stand	390190



# Accessory Holder for Bench Carver

US

## Product Features

- Keeps accessories organized, visible, and accessible

## Ordering information

DESCRIPTION	PRODUCT NUMBER
Accessory Holder for Bench Carver	2500M



# Dust Collector for Bench Carver

US

## Product Features

- Works with most workshop vacuum systems
- Flexible gooseneck for wide range of adjustment
- Appropriate for bench carvers and for hand-held sanding tools

## Ordering information

DESCRIPTION	PRODUCT NUMBER
Dust Collector for Bench Carver	2500L





## Drill Attachments 1/2"-13 Thread

US



### Ordering information

PRODUCT FEATURES	PRODUCT NUMBER
Trautman Drill Attachment - Fits up to 3/8 in. shaft	<b>2100S</b>
Trautman Mini Drill Attachment - Fits up to 1/8 in. shaft	<b>2100R</b>

## Cutters & Replacement Blades

US



2100B

2100H

### Ordering information

#### CUTTERS

DESCRIPTION	PRODUCT NUMBER
Cutter, 1/2"-13 Thread, large	<b>2100B</b>
Cutter, 1/2"-13 Thread, small	<b>2100H</b>

#### REPLACEMENT BLADES

DESCRIPTION	PRODUCT NUMBER
Replacement Blades, small	<b>2100HB</b>

# Soft Foam Shaper

US

## Specifications

Length: 5 in. (12 cm)                      Thread: 5/8"-11  
 Max. Diameter Schmid Carver: 2-3/4 in.



## Product Features

- Ideal for contouring both inner and outer areas of foam cover
- Fine steel bristles barely protrude through surface so foam material may be shaped quickly and removed to obtain the desired cosmetic finish
- Trautman Router Adapter required (PN 225029)

## Ordering information

DESCRIPTION	PRODUCT NUMBER
Soft Foam Shaper	<b>51391</b>

# Shaft Foam Arbors

US

## Ordering information

### FOAM ARBOR FOR FLOOR CARVER

DESCRIPTION	PRODUCT NUMBER
Shaft Foam Arbor for Floor Carver, 3 × 9 in.	<b>2100X</b>

### FOAM ARBOR FOR BENCH CARVER

DESCRIPTION	PRODUCT NUMBER
Shaft Foam Arbor for Bench Carver, 3 × 5-1/2 in.	<b>2500X</b>

### 2100X SAND CONES

DESCRIPTION	PRODUCT NUMBER
Sand Cone for 2100X, 36 Grit	<b>225240</b>
Sand Cone for 2100X, 60 Grit	<b>225242</b>
Sand Cone for 2100X, 120 Grit	<b>225244</b>

### 2500X SAND CONES

DESCRIPTION	PRODUCT NUMBER
Sand Cone for 2500X, 36 Grit	<b>225230</b>
Sand Cone for 2500X, 60 Grit	<b>225232</b>
Sand Cone for 2500X, 120 Grit	<b>225234</b>





# Urethane and Felt Arbors

US

## Product Features

- **Urethane Arbors:** Most commonly used for shaping soft foam covers
- **Felt Arbors:** Used for polishing plastic edges
- Can be shaped to any contour



225080

225066

## Ordering information

### URETHANE FEATURES

DESCRIPTION	PRODUCT NUMBER
Urethane Arbor, 3 × 5 in., 5/8"-11 Thread	<b>225080</b>
Urethane Arbor, 3 × 5 in., 1/2"-13 Thread	<b>225082</b>
Urethane Arbor, 1.5 × 4.5 in., 5/8"-11 Thread	<b>225520</b>

### FELT ARBORS

DESCRIPTION	PRODUCT NUMBER
Felt Arbor, 2 × 3 in. with 1/2"-13 Thread	<b>225066</b>
Felt Arbor, 2.5 × 4 in. with 1/2"-13 Thread	<b>225064</b>
Felt Arbor, 3 × 4 in. with 1/2"-13 Thread	<b>225062</b>

# Pneumatic Sand Drum

US

## Ordering information

### PNEUMATIC SAND DRUM 3.5 X 5 IN.

DESCRIPTION	PRODUCT NUMBER
Pneumatic Sand Drum, 1/2"-13 Thread	<b>224100</b>



### SAND DRUM SLEEVES - PNEUMATIC

DESCRIPTION	PRODUCT NUMBER
Sand Sleeve, 120 Grit	<b>224101</b>
Sand Sleeve, 80 Grit	<b>224102</b>
Sand Sleeve, 36 Grit	<b>224103</b>

# Sand Drum

US



2100F

2100G

## Ordering information

### SAND DRUM - SMALL, 3 IN. LONG

DESCRIPTION	PRODUCT NUMBER
Barrel Shape, Small, 1/2"-13 Thread	<b>2100F</b>
<b>SPARE PARTS</b>	
R2100F-DC - Drum Cover, Foam Rubber	
R2100F-DB - Hold Down Bar	

### SAND SHEETS - SMALL

DESCRIPTION	PRODUCT NUMBER
Sand Sheet, 60 Grit	<b>F60</b>
Sand Sheet, 120 Grit	<b>F120</b>

### SAND DRUM - LARGE, 3.5 IN. LONG

DESCRIPTION	PRODUCT NUMBER
Barrel Shape, Large, 1/2"-13 Thread	<b>2100G</b>
<b>SPARE PARTS</b>	
R2100G-DC - Drum Cover, Foam Rubber	
R2100G-DB - Hold Down Bar	

### SAND SHEETS - LARGE

DESCRIPTION	PRODUCT NUMBER
Sand Sheet, 60 Grit	<b>G60</b>
Sand Sheet, 120 Grit	<b>G120</b>



# Rubber Sand Cones

US

## Specifications

Length: 4-3/8 in. (111 mm)

Thread: 1/2"-13

## Ordering information

### Mini Sand Core



#### MINI SAND CORE

DESCRIPTION	PRODUCT NUMBER
Sand Core, Mini	<b>2100P</b>

#### MINI SANDING SLEEVES

DESCRIPTION	PRODUCT NUMBER
Mini 50 Grit	<b>P50</b>
Mini 100 Grit	<b>P100</b>
Mini 180 Grit	<b>P180</b>

#### MINI POLISHING CONE

DESCRIPTION	PRODUCT NUMBER
Mini, Fine, Blue	<b>225117</b>
Mini, Medium, Maroon	<b>225118</b>
Mini, Coarse, Brown	<b>225119</b>

### Small Sand Core



#### SMALL SAND CORE

DESCRIPTION	PRODUCT NUMBER
Sand Core, Small	<b>2100D</b>

#### SMALL SANDING SLEEVES

DESCRIPTION	PRODUCT NUMBER
Small 24 Grit	<b>D24</b>
Small 80 Grit	<b>D80</b>
Small 120 Grit	<b>D120</b>

#### SMALL POLISHING CONE

DESCRIPTION	PRODUCT NUMBER
Small, Fine, Blue	<b>225111</b>
Small, Medium, Maroon	<b>225112</b>

### Medium Sand Core



#### MEDIUM SAND CORE

DESCRIPTION	PRODUCT NUMBER
Sand Core, Medium	<b>2100C</b>

#### MEDIUM SANDING SLEEVES

DESCRIPTION	PRODUCT NUMBER
Medium 24 Grit	<b>C24</b>
Medium 80 Grit	<b>C80</b>
Medium 120 Grit	<b>C120</b>
Medium 180 Grit	<b>C180</b>
Medium 240 Grit	<b>C240</b>
Medium 320 Grit	<b>C320</b>

#### MEDIUM POLISHING CONE

DESCRIPTION	PRODUCT NUMBER
Medium, Fine, Blue	<b>225114</b>
Medium, Medium, Maroon	<b>225115</b>
Medium, Coarse, Brown	<b>225116</b>



# Tapered Felt Arbor/ Core

US



## Ordering information

### 1×4 IN. FELT ARBORS & SAND CONES

DESCRIPTION	PRODUCT NUMBER
Tapered Felt Arbor, 1 × 4 in., 1/2"-13 Thread	<b>225072</b>
1 × 4 in. Sand Cone, 80 Grit	<b>225173</b>
1 × 4 in. Sand Cone, 120 Grit	<b>225175</b>

### 1.5×4 IN. FELT ARBORS & SAND CONES

DESCRIPTION	PRODUCT NUMBER
Tapered Felt Arbor, 1.5 × 4 in., 1/2"-13 Thread	<b>225070</b>
Tapered Felt Arbor, 1.5 × 4 in., 5/8"-11 Thread	<b>225177</b>
1.5 × 4 in. Sand Cone, 36 Grit	<b>225151</b>
1.5 × 4 in. Sand Cone, 100 Grit	<b>225169</b>
1.5 × 4 in. Sand Cone, 120 Grit	<b>225171</b>

### 2×4 IN. FELT ARBORS & SAND CONES

DESCRIPTION	PRODUCT NUMBER
Tapered Felt Arbor, 2 × 4 in., 1/2"-13 Thread	<b>225068</b>
Tapered Felt Arbor, 2 × 4 in., 5/8"-11 Thread	<b>225128</b>
2 × 4 in. Sand Cone, 36 Grit	<b>225136</b>
2 × 4 in. Sand Cone, 80 Grit	<b>225141</b>



# Expansion Arbors

US

## Specifications

Warranty: 6 months against manufacturing defects

## Product Features

- Expands to apply inside pressure to the sanding sleeve to hold it in place
- Prevents migration and “Fly away” of sanding sleeve
- Provides a smoother grinding surface for straighter lines and higher quality finish
- Eliminates grinding chatter that hard grinding surfaces gives
- Sold individually and as a kit of three
- Available in 1/2”-13, 5/8”-11 and M16 threads to fit most O&P machinery



## Ordering information

### EXPANSION ARBOR KITS

DESCRIPTION	PRODUCT NUMBER
1/2-13 Threads	225380
5/8-11 Threads	225385
M16 Threads	225380MM

### Mini



#### MINI EXPANSION ARBOR

DESCRIPTION	PRODUCT NUMBER
1/2”-13 Thread	225350
5/8”-11 Thread	225360
M16 Thread	225350MM

#### MINI SANDING SLEEVES

DESCRIPTION	PRODUCT NUMBER
Mini 50 Grit	P50
Mini 100 Grit	P100
Mini 180 Grit	P180

### Small



#### SMALL EXPANSION ARBOR

DESCRIPTION	PRODUCT NUMBER
1/2”-13 Thread	225352
5/8”-11 Thread	225362
M16 Thread	225352MM

#### SMALL SANDING SLEEVES

DESCRIPTION	PRODUCT NUMBER
Small 24 Grit	D24
Small 80 Grit	D80
Small 120 Grit	D120

### Medium



#### MEDIUM EXPANSION ARBOR

DESCRIPTION	PRODUCT NUMBER
1/2”-13 Thread	225354
5/8”-11 Thread	225364
M16 Thread	225354MM

#### MEDIUM SANDING SLEEVES

DESCRIPTION	PRODUCT NUMBER
Medium 24 Grit	C24
Medium 80 Grit	C80
Medium 120 Grit	C120
Medium 180 Grit	C180 (metal use)
Medium 240 Grit	C240 (metal use)
Medium 320 Grit	C320 (metal use)

# Dual Purpose Expansion Arbors

US

## Specifications

**Warranty:** 6 months against manufacturing defects

## Product Features

- Sand and polish without changing tools
- Removable, tapered polishers for easy replacement

## Ordering information

### Small



#### SMALL DUAL PURPOSE

DESCRIPTION	PRODUCT NUMBER
1/2"-13 Threads	<b>225330</b>
5/8"-11 Threads	<b>225335</b>
M16 Threads	<b>225330MM</b>
Slim Blue Coneiak, Replacement tip	<b>225345</b>

#### SMALL SANDING SLEEVES

DESCRIPTION	PRODUCT NUMBER
Small 24 Grit	<b>D24</b>
Small 80 Grit	<b>D80</b>
Small 120 Grit	<b>D120</b>

### Medium



#### MEDIUM DUAL PURPOSE

DESCRIPTION	PRODUCT NUMBER
1/2"-13 Threads	<b>225320</b>
5/8"-11 Threads	<b>225325</b>
M16 Threads	<b>225320MM</b>
Tapered Red Coneiak, Replacement tip	<b>225340</b>

#### MEDIUM SANDING SLEEVES

DESCRIPTION	PRODUCT NUMBER
Medium 24 Grit	<b>C24</b>
Medium 80 Grit	<b>C80</b>
Medium 120 Grit	<b>C120</b>
Medium 180 Grit	<b>C180 (metal use)</b>
Medium 240 Grit	<b>C240 (metal use)</b>
Medium 320 Grit	<b>C320 (metal use)</b>



# Grinding Rasps

US

## Product Features

**Warranty:** 6 months against manufacturing defects

- High-quality steel
- Sharp teeth
- Long usage

## Ordering information

### 5/8"-11 THREAD\*

DESCRIPTION	PRODUCT NUMBER
1-1/2 × 2-1/4 in. - Use on Transtibial Sockets, Coarse	<b>225052</b>
1-3/8 × 3-3/8 in. - Small Diameter and Channel Work, Coarse	<b>225045</b>
1-3/8 × 2-1/8 in. - Extra Fine	<b>225060</b>
1-3/4 × 3-1/8 in. - General Transfemoral Socket Work, Coarse	<b>225037</b>

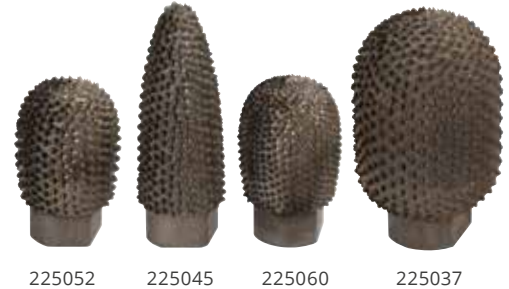

\*Must have router adapter for 5/8-11 threaded Rasps

### 1/2"-13 THREAD

DESCRIPTION	PRODUCT NUMBER
Rasp	<b>2100E</b>
Carbide Grind Rasp, Large, Coars	<b>225252</b>
Carbide Grind Rasp, Large, Fine	<b>225256</b>
Carbide Grind Rasp, Small, Coarse	<b>225262</b>
Carbide Grind Rasp, Small, Fine	<b>225266</b>

Used most commonly for grinding laminated sockets



# Router Adapters

US

## Specifications

**Warranty:** 6 months against manufacturing defects

## Ordering information

### 1/2"-13 INTERNAL THREAD

DESCRIPTION	PRODUCT NUMBER
5/8-11 External Thread	<b>225029</b>
M16 External Thread	<b>225017</b>



### 1/2"-13 EXTERNAL THREAD

DESCRIPTION	PRODUCT NUMBER
5/8-11 Internal Thread	<b>225011</b>
M16 Internal Thread	<b>225016</b>



# Tycro Polishing Arbor

US

## Specifications

Warranty: 6 months against manufacturing defects



225110

225100

## Ordering information

### TYCRO POLISHING ARBOR

DESCRIPTION	PRODUCT NUMBER
Tycro Polishing Arbor, 3 x 3-1/2 in., Double Ended with 5/8 in. and 1/2 in. Thread	<b>225110</b>

### TYCRO ACCESSORIES

DESCRIPTION	PRODUCT NUMBER
Tycro Cone, 4 x 1 in. (Requires 225090)	<b>225100</b>
Tycro Cone Adapter, 1/2 in. Thread	<b>225090</b>



# Trautman Coneiak Polishing Arbors

US

## Specifications

**Warranty:** 6 months against manufacturing defects

## Product Features

- All Coneiak Polishing Arbors work well with any standard thermoplastic materials within the O&P industry.
- For best results, drill attachment 2100S (large) or 2100R (small) should be used
- If using a rotary hand tool, the maximum speed should not exceed 10,000 RPMs
- Ensure that the shaft is at least halfway into chuck



225600    225615    225605    225620    225610  
 ..... 225650 .....

## Ordering information - Coneiak Mini Polishing Arbor

DESCRIPTION	SHAFT	PRODUCT NUMBER
Set of Five Coneiak Minis	1/8 in.	<b>225650</b>
Tapered Coneiak Mini	1/8 in.	<b>225600</b>
Ball Nose Coneiak Mini	1/8 in.	<b>225615</b>
Slim Coneiak Mini	1/8 in.	<b>225605</b>
Cylindrical Coneiak Mini	1/8 in.	<b>225620</b>
Double Ended Coneiak Mini	1/8 in.	<b>225610</b>

## Ordering information - Trautman Coneiak Polishing Arbor

US

### SET OF FOUR CONEIAKS

DESCRIPTION	PRODUCT NUMBER
1/2"-13 Thread	225490
5/8"-11 Thread	225495
M16 Thread	225490MM



### TAPERED CONEIAK

DESCRIPTION	PRODUCT NUMBER
1/2"-13 Thread	225410
5/8"-11 Thread	225415
M16 Thread	225410MM



### BALL NOSE CONEIAK

DESCRIPTION	PRODUCT NUMBER
1/2"-13 Thread	225400
5/8"-11 Thread	225405
M16 Thread	225400MM



### SLIM CONEIAK

DESCRIPTION	PRODUCT NUMBER
1/2"-13 Thread	225440
5/8"-11 Thread	225445
M16 Thread	225440MM



### CYLINDRICAL CONEIAK

DESCRIPTION	PRODUCT NUMBER
1/2"-13 Thread	225450
5/8"-11 Thread	225455
M16 Thread	225450MM



### HOURLASS CONEIAK

DESCRIPTION	PRODUCT NUMBER
1/2"-13 Thread	225430
5/8"-11 Thread	225435
M16 Thread	225430MM



### GROOVED CONEIAK

DESCRIPTION	PRODUCT NUMBER
1/2"-13 Thread	225420
5/8"-11 Thread	225425
M16 Thread	225420MM



### DOUBLE DUROMETER

DESCRIPTION	PRODUCT NUMBER
1/2"-13 Thread	225460
5/8"-11 Thread	225465
M16 Thread	225460MM





# Trautman Vacuum Systems

## Specification symbols

---

**SE** Manufactured in Sweden

---

**US** Manufactured in USA

---



# Mobile Vacuum Unit

US

## Specifications

**Warranty:** 12 months from the date of shipment



## Product Features

- Multifunction table top for pipe-mounted platens, vacuum forming, or pipe-holding fixture for horizontal vacuum forming
- Master cut-off valve and three-way valve
  - Neutral (Off) position
  - High vac line—full vacuum direct from vacuum source
  - Low vac line—controlled by regulator
- Veritable On/Off foot pedal
- Filter and water trap (wet plaster models release 4–6 oz. of water which could contaminate regulator, gauges, and pump)
- Two 3 gallon surge tanks for rapid vacuum

## Ordering information

Note: Pump is sold separately.

DESCRIPTION	PRODUCT NUMBER
Mobile Vacuum Unit	227305
<b>SPARE PARTS</b>	
227503 - Surge Tanks	
227511 - Master Cut-Off Valve	
227529 - Three-Way Valve	
227537 - Regulator	
227545 - Gauge	
227552 - Filter-Water Trap	
227560 - On/Off Foot Control	



# Vacuum Control Assembly

US

## Ordering information

DESCRIPTION	PRODUCT NUMBER
Vacuum Control Assembly	<b>227500</b>
<b>SPARE PARTS</b>	
227511 - Master Cut-Off Valve	227545 - Gauge
227529 - Three-Way Valve	227552 - Filter-Water Trap
227537 - Regulator	



# Portable Oilless Vacuum Pump

US

## Product Features

- 1/3 Horse Power oilless motor
- Enough power to operate two vacuum laminating jigs simultaneously
- 4 cubic feet per minute capacity
- Adjustable vacuum from 3 - 27 in. of mercury (10 - 90 kPa)
- Available in single and dual vacuum
- US plug 115 V, 50/60 Hz Single Phase Motor or EU 230 v, 50 Hz
- Reversible to become air supply as well as vacuum
- 12 month warranty from date of shipment



## Ordering information

DESCRIPTION	PRODUCT NUMBER
Portable Single Oilless Vacuum Pump, 115 V	<b>227005</b>
Portable Dual Oilless Vacuum Pump, 115 V	<b>227020</b>
Portable Single Oilless Vacuum Pump, 230 V	<b>227006</b>
Portable Dual Oilless Vacuum Pump, 230 V	<b>227021</b>

# Holding Frames

US

## Product Features

- Black powder coated for durability

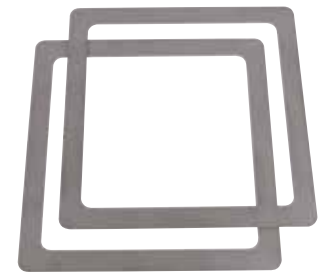

## Ordering information

Note: Sold per pair

DESCRIPTION	PRODUCT NUMBER
Holding Frames, 12 × 12 in.	227420
Holding Frames, 16 × 16 in.	227438
Holding Frames, 18 × 18 in.	227443
Holding Frames, 20 × 20 in.	227449
Holding Frames, 22 × 22 in.	227450
Holding Frames, 24 × 24 in.	227451

# Drape Forming Adapters

US



## Ordering information

### DRAPE FORMING ADAPTER

DESCRIPTION	PRODUCT NUMBER
Drape Forming Adapter, Straight	227497
Drape Forming Adapter, Angled	227495

### PLATEN

DESCRIPTION	PRODUCT NUMBER
9 in. Platen	227354
12 in. Platen	227347



# Trautman Vacuum Stations

**US**

## Specifications

**Warranty:** 12 months from the date of shipment

## Product Features

The Trautman Dual Bladder Vacuum Station allows for a variety of options in vacuum forming. The station can be used as either a dual bladder or single bladder vacuum system. The dual bladder configuration allows for better mold preservation during vacuum forming and improved surface quality of the molded product. This allows the product to be more consistent and visually appealing.

Single bladder vacuum stations can be easily upgraded to a dual bladder configuration by purchasing the upgrade kit (see optional accessories below).

- Durable, powder coated, aluminum frame
- High temperature, non-stick, clear silicone bladder
- Dual bladder for use with Comfil®TFC and pre-preg materials
- Quick change outer bladder saves time and money
- Exterior dimension: 24 × 24 in. (61 × 61 cm)
- Work area 18.5 × 18.5 in. (47 × 47 cm)
- Requires vacuum source



## Ordering information

### TRAUTMAN VACUUM STATIONS

DESCRIPTION	PRODUCT NUMBER
Dual Bladder Vacuum Station	<b>227730</b>
Single Bladder Vacuum Station	<b>227728</b>

### ACCESSORIES

DESCRIPTION	PRODUCT NUMBER
Dual Bladder Upgrade	<b>227729</b>
Outer Bladder	<b>227752</b>
Inner Bladder	<b>227751</b>

# PDQ Ovens

## Specification symbols

.....  
**SE** Manufactured in Sweden  
.....

**US** Manufactured in USA  
.....



# PDQ Rollabout Oven

**US**

## Specifications

**Electrical requirements:** US 208 - 240 V single phase  
EU 380 - 460 V three phase

**Warranty:** 12 months from the date of shipment

## Product Features

A Rollabout model is an excellent solution for heating large sheets of plastic for hip. There are 4 different sizes to meet every thermoforming need, and each features a hydraulic assisted height adjustable tray for easy operation. The tray includes a fitted Teflon® cover, is mounted on casters, and can be rolled to your vacuum area. No more burnt arms or trying to find a place to set down your hot plastic.

- Aluminum and stainless steel construction
- 650 watt infrared emitters (1000 watt on 8E & 8D)
- Double pane viewing window & interior light
- Programmable digital temperature controller
- Tray includes a fitted Teflon® cover
- NOTE: 208 - 240 V, single phase ovens delivered without cord  
380 - 460 V, three phase ovens delivered with cord, no plug



Shown with the PDQ Oven Fan Kit.  
See page 37 for more information.

## Dimensions

MODEL	INTERIOR DIMENSIONS (W X D X H)	EXTERIOR DIMENSIONS (W X D X H)	WEIGHT
PDQ-5A	38 × 31 × 18 in. (965 x 787 x 457 mm)	49 × 35 × 48 in. (1244 x 889 x 1219 mm)	350 lbs. (159 kg)
PDQ-6B	36 × 51 × 18 in. (914 x 1295 x 457 mm)	47 × 55 × 48 in. (1194 x 1397 x 1219 mm)	450 lbs. (204 kg)
PDQ-7C	48 × 51 × 18 in. (1219 x 1295 x 457 mm)	59 × 55 × 48 in. (1499 x 1397 x 1219 mm)	460 lbs. (209 kg)
PDQ-8E	60 × 50 × 18 in. (1524 x 1219 x 457 mm)	70 × 52 × 48 in. (1778 x 1321 x 1219 mm)	475 lbs. (215 kg)
PDQ-8D	80 × 50 × 18 in. (2032 x 1219 x 457 mm)	92 × 54 × 48 in. (2337 x 1372 x 1219 mm)	800 lbs. (363 kg)

## Ordering information

MODEL	PROD NO. EU 400 V, 50 HZ, THREE PHASE
PDQ-5A	<b>O5A-INT</b>
PDQ-6B	<b>O6B-INT</b>
PDQ-7C	<b>O7C-INT</b>
PDQ-8E	<b>O8E-INT</b>
PDQ-8D	<b>O8D-INT</b>

# PDQ BT-1 Benchttop Infrared Oven

US

## Specifications

Electrical requirements: US 208 - 240 V single phase  
EU 380 - 460 V three phase

Warranty: 12 months from the date of shipment

## Product Features

The BT-1 Infrared Oven incorporates the infrared efficiency design of all our full size ovens. The BT-1 model is intended for flat plastics only.

- Aluminum and stainless steel construction
- Weight (uncrated) 250 lbs
- Four 650 watt quartz infrared emitters
- Interior light
- Double pane viewing window
- Digital temperature controller (0-550°F, +/- 2)
- NOTE: US 220 V, single phase ovens delivered without cord  
EU 440 V, three phase ovens delivered with cord, no plug

## Ordering information

MODEL	INTERIOR DIMENSIONS (W x D x H)	EXTERIOR DIMENSIONS (W x D x H)	PRODUCT NUMBER
PDQ-BT-1	38 x 30 x 6 in. (965 x 762 x 152 mm)	42 x 43 x 20 in. (1067 x 1092 x 508 mm)	<b>OBT1</b>





# PDQ BT-4 Infrared Oven

**US**

## Specifications

**Electrical requirements:** US 208 - 240 V single phase  
EU 380 - 460 V three phase

**Warranty:** 12 months from the date of shipment

## Product Features

The BT-4 is capable of bubble forming and heating sheet plastic while taking up a minimal amount of floor space. The BT-4 Infrared Oven is big enough to heat most KAFO sheet plastics and has enough drop for even the biggest check socket.

The BT-4 has the same speed and reliability you've come to expect from PDQ Infrared Ovens. The eight 1000 watt emitters, four on top and four on bottom, along with the dual electric fans allow bubble forming plastics to be heated evenly and efficiently. The BT-4 is truly the best of both worlds with its small size and large capacity.

- Eight 1000 watt emitters; four on top and four on bottom
- Programmable digital temperature controller
- Dual electric fans for air circulation
- Access point for vacuum line
- 4 interior lights and large viewing window
- Sheet plastic tray with fitted Teflon® cover
- Aluminum and powder coated protective finish
- 18 in. (46 cm) clearance for bubble forming
- NOTE: US 220 V, single phase ovens delivered without cord  
EU 440 V, three phase ovens delivered with cord, no plug



## Ordering information

MODEL	INTERIOR DIMENSIONS (W x D x H)	EXTERIOR DIMENSIONS	PRODUCT NUMBER
PDQ-BT-4	27 × 40 × 24 in. (686 x 1016 x 610 mm)	32 × 49 × 61 in. (813 x 1245 x 1549 mm)	<b>o-BT4-INT</b>



# PDQ PO-2 Infrared Oven

US

## Specifications

**Electrical requirements:** US 208 - 240 V single phase  
EU 380 - 460 V three phase

**Warranty:** 12 months from the date of shipment

## Product Features

Designed with banks of lights on top and bottom to facilitate the quick and even forming of thick plastics.

Instead of having to reach into a hot oven for bubble forming frames, the PO-2 model now has a rollabout tray that holds either frames or trays for heating flat plastic. Just roll the cart out to your mold.

- Aluminum and stainless steel construction
- Quartz infrared tubes top and bottom
- Eight 1000 watt quartz infrared tubes (four on top and four on bottom)
- Interior light
- Two double pane viewing windows
- Programmable digital temperature controller (accurate to within 2°)
- Rollabout bubble forming rack/sheet plastic tray with fitted Teflon® cover
- Bubble Forming Frame (specify size at time of ordering)
- Full 1 year warranty
- NOTE: US 220 V, single phase ovens delivered without cord  
EU 440 V, three phase ovens delivered with cord, no plug

## Ordering information

MODEL	INTERIOR DIMENSIONS (W x D x H)	EXTERIOR DIMENSIONS	PRODUCT NUMBER
PDQ-PO-2	50 x 36 x 20 in. (1270 x 914 x 508 mm)	60 x 40 x 53 in. (1524 x 1016 x 1346 mm)	<b>OPO2</b>





# PDQ Oven Fan Kit

US

## Product Features

- Available as a retrofit kit for an existing PDQ Infrared Oven
- Available as factory-installed accessory on a new PDQ Infrared Oven
- Provides controlled heating of Pre-Preg and TFC materials
- Reduces production time by as much as 20 percent for O&P plastics
- Fits all models except BT-1 and BT-4

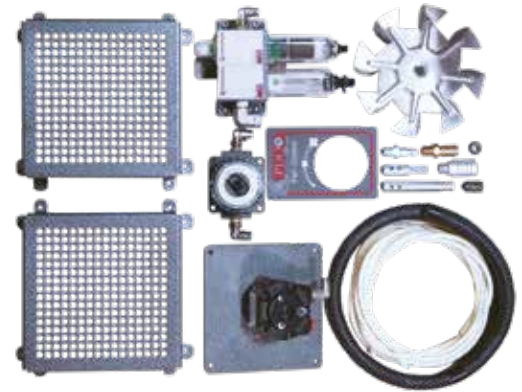

## Ordering information

DESCRIPTION	PRODUCT NUMBER
Oven Fan Kit, for Retrofit	<b>OFANKIT</b>
Oven Fan Kit, for Factory Installed Accessory with oven order	<b>OFANNEW</b>

# Tongue Tray

US

## Product Features

1/2 in. H x 24 in. W x 24 in. D



## Ordering information

DESCRIPTION	PRODUCT NUMBER
Tongue Tray	<b>TRAYTONGUE</b>

# PDQ Oven Gloves

US

## Product Features

- Provides protection against heat up to 250°F (120°C)
- 100% cotton
- 11 in. (28 cm) long for up to the elbow coverage



## Ordering information

DESCRIPTION	PRODUCT NUMBER
PDQ Long Thermal Gloves	<b>ORSUPGLOVE</b>

# Fabrication Equipment

## Specification symbols

---

**SE** Manufactured in Sweden

---

**US** Manufactured in USA

---



# Laminating Fixture LJ-100

US

## Product Features

- Height: 24 in. (61 cm)
- Width: 17 in. (43 cm)
- May be positioned to hold cast at any angle or degree of rotation
- Large PVA tie-off ring and hose attachments for inside and outside vacuum lines make laminating easier and faster

## Ordering information

DESCRIPTION	PRODUCT NUMBER
Laminating Fixture Complete, LJ-100	<b>51454</b>
Vacuum Device Assembly Only	<b>51459</b>
Vacuum Laminating Assembly Only	<b>51455</b>

### SPARE PARTS FOR LJ100

- A. 51462 - Clamp Assembly
- B. 51463 - Post Base Assembly
- C. 52062 - Clamp Assembly
- D. 51271 - Hose Connector
- E. 51458 - Stopper
- F. 51457 - Plug
- G. 51456 - Pipe Lock
- H. Surgical Tubing (See Below)
- I. 55706 - Lamination Mandrell
- 51275 - Hose, Tie-Off 3/16 in., (Not Shown)

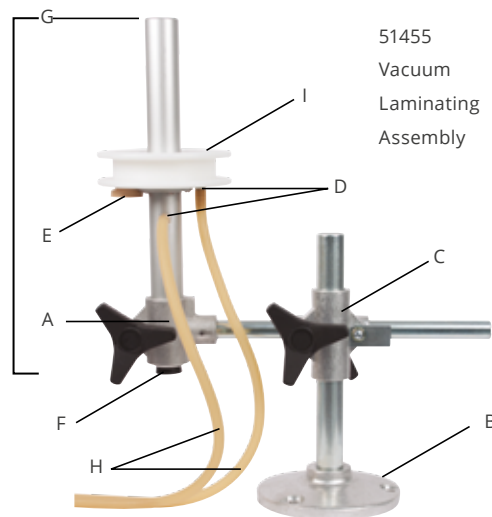

51459 Vacuum Laminating Device

# Surgical Tubing

US

## Product Features

- High quality, pure latex tubing
- May be used as hose on vacuum or to securely tie-off PVA bags on the Vacuum Laminating Fixture, LJ-100



## Ordering information

DESCRIPTION	PRODUCT NUMBER
Surgical Tubing, 0.25 in. (6.4 mm) Diameter, 6 ft. (183 cm) Increments Only	<b>51273</b>
Surgical Tubing, 0.19 in. (4.8 mm) Diameter, per foot	<b>51275</b>

# Vertical Fabricating Fixture, VFJ-100

US

## Product Features

- Height: 48-3/4 in. (124 cm)
- Width: 21 in. (53 cm)
- Horizontal operation
- Heavy-duty for long life
- Retractable handle when not in use
- Will form full circle without restriction



## Ordering information

DESCRIPTION	PRODUCT NUMBER
Vertical Fabricating Fixture, VFJ-100	<b>52056</b>
Vertical Swivel Module	<b>61714</b>
VFJ-Ball Joint Module	<b>58188</b>
Lutz Adapter Kit, with Endoskeletal Adapters	<b>58641</b>
Flex Foot/Spring Lite LOHO Bock Adapter	<b>58640</b>
Endoskeletal Adapter, (Requires PN 58640)	<b>58633</b>



# Bar Contouring Device

US

## Product Features

- **Height:** 36 in. (914 mm)
- **Base area:** 24 x 38 in. (610 x 965 mm)
- Heavy-duty for long life
- Retractable handle when not in use
- Operates in two directions, in and out
- Available as floor model (with stand)
- Will form full circle without restriction

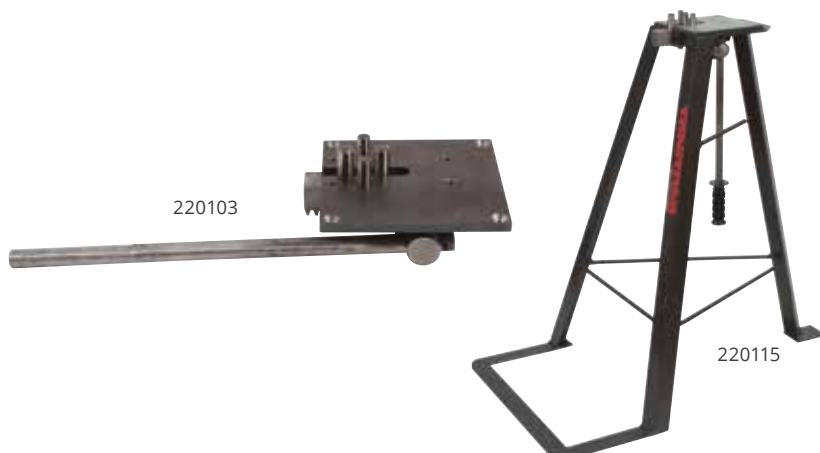

## Ordering information

DESCRIPTION	PRODUCT NUMBER
Bar Contouring Device	220103
Bar Contouring Device, with Stand	220111
Stand Only	220115

# Pipe Holding Fixtures

US

## Ordering information

DESCRIPTION	PRODUCT NUMBER
Pipe Holding Fixture, Vice Mount	220129
Bench Mounted Pipe Holding Fixture, 8 in. Hi	220131
Friction Block	220135
Laminating Stand with Pipe Holding Fixture Adjustable in Height to 60 in. (152 cm), 15 - 18 in. (381 - 457 mm) Diameter	220133



# Prosthetic Bench Vise

US

## Product Features

- Tough, resilient pads
- Opens to 16 in. (406 mm) with an 8 in. (203 mm) depth
- Swivel jaw, 6 × 6 in. (152 x 152 mm)



## Ordering information

DESCRIPTION	PRODUCT NUMBER
Prosthetic Bench Vise	<b>220178</b>
Replacement Pads	<b>220301</b>

# Cable Swaging Tool

US

## Product Features

- May be used in any standard bench vise
- Made of heat treated steel



## Ordering information

DESCRIPTION	PRODUCT NUMBER
Cable Swaging Tool, for Three Sizes of Cable Size Fittings	<b>50520</b>

### REPLACEMENT DIE

DESCRIPTION	PRODUCT NUMBER
Replacement Die, 3/64 in. (0.119cm)	<b>US 524</b>
Replacement Die, 1/16 in. (0.159cm)	<b>50523</b>
Replacement Die, 3/32 in. (0.238cm)	<b>50522</b>



# Drill Press Fixture

US

## Product Features

- For intricate orthotic and prosthetic work
- Less bulky than a table



## Ordering information

DESCRIPTION	PRODUCT NUMBER
Drill Press Fixture, 2 - 2.25 in. (51 - 57 mm) Diameter	<b>220160</b>
Drill Press Fixture, 2.5 - 2.75 in. (64 - 70 mm) Diameter	<b>220162</b>
Drill Press Fixture, 3 - 3.25 in. (76 - 83 mm) Diameter	<b>220164</b>

# Universal Alignment Fixture

US

## Ordering information



DESCRIPTION	PRODUCT NUMBER
Universal Alignment Fixture	<b>220128</b>

# Stirrup Bender

## Product Features

- Length: 25 in. (381 mm)
- Width capacity: 3-5/8 in. (92.1 mm)

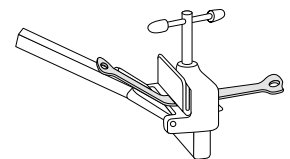

## Ordering information

DESCRIPTION	PRODUCT NUMBER
Stirrup Bender	<b>220038</b>



# Contouring Fork and Bench Receptacle

US

## Product Features

- Heat-treated stainless steel
- Mounts flush on work bench or in work bench vise

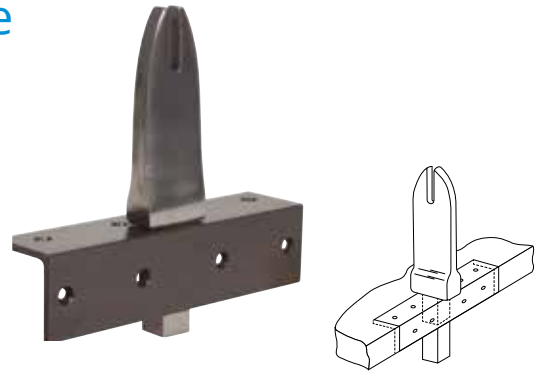

## Ordering information

DESCRIPTION	PRODUCT NUMBER
Contouring Fork, 5/16 in. Throat	<b>220194</b>
Contouring Fork, 1/4 in. Throat	<b>220186</b>
Bench Receptacle	<b>220202</b>
Fork and Receptacle Set, 1/4 in. Throat	<b>220210</b>
Fork and Receptacle Set, 5/16 in. Throat	<b>220293</b>

# Joint Alignment Tool

US

## Product Features

- Use for both small and large stirrups

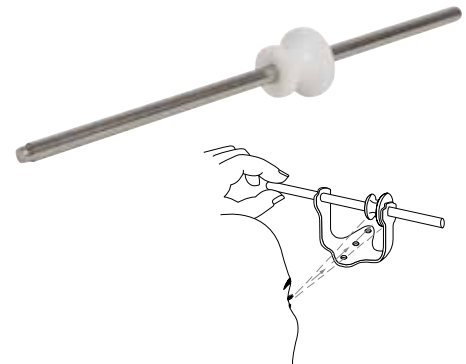

## Ordering information

DESCRIPTION	PRODUCT NUMBER
Alignment Tool, Universal 0.25 in. diameter × 8 in. long rod	<b>220194</b>



## Bending Irons

US

### Product Features

- 8 in. (203 mm) long, 1/4 in. (6.4 mm) thickness capacity
- Stainless steel
- Provides smooth bending of side bars
- Sold as a pair



### Ordering information

DESCRIPTION	PRODUCT NUMBER
Bending Irons	54795

## Contouring Irons

US

### Product Features

- Nickel plated bronze
- Wide-radius jaws
- Sold as a pair
- Will not mark finished metal or leather work



### Ordering information

DESCRIPTION	PRODUCT NUMBER
Rounded Polished Jaws	220285

# Spring Clamps

US



## Ordering information

DESCRIPTION	PRODUCT NUMBER
Spring Clamps Set (4 Each)	<b>227594</b>

# Yates Clamp

US

## Product Features

- Holds harness during fitting



## Ordering information

DESCRIPTION	LENGTH	PRODUCT NUMBER
Wire Spring Type, W1 Small	3.1 in. (8 cm)	<b>52115</b>
Wire Spring Type, W2 Medium	3.7 in. (9.5 cm)	<b>52116</b>
Rubber Pads, for 52115 and 52116		<b>52872</b>

# Scissors



5-514

## Ordering information

DESCRIPTION	PRODUCT NUMBER
Bandage Scissors, 5.5 in. (140 mm)	<b>5-514</b>
Bandage Scissors, 7.25 in. (184 mm)	<b>5-516</b>
Bandage Scissors, 8 in. (203 mm)	<b>5-550</b>
Bandage Scissors, 8 in. Heavy-Duty (203 mm)	<b>5-568</b>



# Tools

US

## Hex Screwdriver



DESCRIPTION	PRODUCT NUMBER
Hex Screwdriver, for U-30/G-2 Adjustment Screws, 4 mm Hex	<b>731000120</b>
Hex Screwdriver, for U-30/G-2 Fixing Screws, 3 mm Hex	<b>731000121</b>

## Hex Keys

US

SE



DESCRIPTION	PRODUCT NUMBER
Hex Key, 4 mm	<b>51293</b>
Hex Key, 5 mm	<b>51352</b>
Hex Key, 3 mm	<b>51353</b>
Hex Key, for 9 mm Locking Screw	<b>731000123</b>
Hex Key, for 6 mm Locking Screw	<b>731000122</b>

## Torque Screwdriver

SE



DESCRIPTION	PRODUCT NUMBER
BOA Torque Screwdriver, 1.6 Nm	<b>731000153</b>
1/4 in. Bits 4 mm Hex, for BOA Torque Screwdriver	<b>731000155</b>

## Torque Wrench

SE



DESCRIPTION	PRODUCT NUMBER
BOA Torque Wrench, 15 Nm	<b>731000150</b>

# Scarpas Knife

US



## Ordering information

DESCRIPTION	PRODUCT NUMBER
Scarpas Knife, Small for Transtibial	<b>220461</b>
Scarpas Knife, Large for Transfemoral	<b>220460</b>

# Surgical Scalpel

US

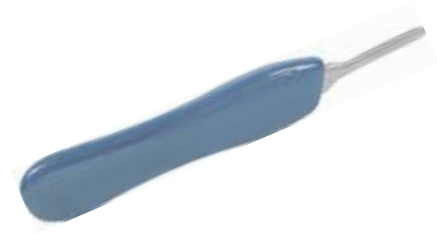

## Ordering information

DESCRIPTION	PRODUCT NUMBER
Scalpel Handle	<b>800050</b>
Blades, Surgical Scalpel, Box (150 Count), #25, 2 in. (51 mm) Long	<b>800060</b>

# Pin Wrench

### Product Features

- Used for tightening: ALP-Ti Female Pyramid Adapter, 731162120 and ALP-Al Female Pyramid Adapter, 731163187



## Ordering information

DESCRIPTION	PRODUCT NUMBER
Pin Wrench DIN1810B-45-50	<b>731000140</b>



## Deburring Tool

US



### Ordering information

DESCRIPTION	PRODUCT NUMBER
Deburring Tool	220321
Deburring Tool, Blade Only	E-100

## Tube Cutter

US

### Product Features

- Pocket size pylon cutter with parallel cut control feature
- Cuts all sizes up to 1-1/8 in. (2.9 cm) diameter
- Comes with two extra cutting wheels



220310

60739

### Ordering information

DESCRIPTION	PRODUCT NUMBER
Tube Cutter	220310
Heavy-Duty Replacement Wheel	220311
Heavy-Duty Replacement Wheel, for Rigid Cutter	220312
Cutting Guide	60739

## Cutting Tool for 30 mm Tubes

US



### Ordering information

DESCRIPTION	PRODUCT NUMBER
Cutting Tool, for 30 mm Carbon Fiber Tube	731000125

# Cast Cutter

US

## Product Features

- Manufacturer's descriptive literature available on request
- Oscillating action quickly cuts through plaster
- Trim plastic sockets and Ortholen splints



## Ordering information

DESCRIPTION	PRODUCT NUMBER
Cast Cutter, 230 V	<b>226226</b>
Cast Cutter Blade, 2.5 in. (64 mm)	<b>226258</b>



# Measuring Tapes

US



220331

220328

220329

## Ordering information

DESCRIPTION	PRODUCT NUMBER
Measuring Tape (Inch/Metric) Fiberglass Retractable, 60 in. (150 cm)	220328
Measuring Tape (Inch/Metric) PVC-Coated, Fiberglass 60 in. (150 cm)	220329
Disposable Measuring Tape, 10 ft. (300 cm)	220331

# Cast Mandrels

US



## Ordering information

DESCRIPTION	PRODUCT NUMBER
Aluminum Cast Mandrel, 1.75 × 7.5 in. (44 x 190 mm)	259056
Aluminum Cast Mandrel, 2.38 × 7.5 in. (61 x 190 mm)	259060
Aluminum Cast Mandrel, 2.38 × 10 in. (61 x 254 mm)	259053
Aluminum Cast Mandrel, 2.38 × 15 in. (61 x 381 mm)	259050

# Surform™ Files

US

## Product Features

- For fast shaping of plaster cast
- Also can be used on wood and plastics



## Ordering information

DESCRIPTION	PRODUCT NUMBER
Flat File 10 in. (254 mm), Complete	21-295

## REPLACEMENT BLADES

DESCRIPTION	PRODUCT NUMBER
Flat Blade	21-293
Half Round Blade	21-299



# Transtibial Length Gauge

US

## Product Features

- Measures in inches and metric



## Ordering information

DESCRIPTION	PRODUCT NUMBER
Transtibial Gauge	220145

# Original AP-ML Gauge

US

## Product Features

- Anatomical measuring tool
- Measures in inches and metric



## Ordering information

DESCRIPTION	PRODUCT NUMBER
Original AP-ML Gauge, 22 in.	220335

# Universal AP-ML Gauge

US

## Product Features

- Anatomical measuring tool
- Measures in inches and metric

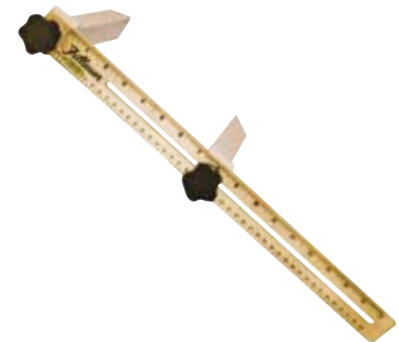

## Ordering information

DESCRIPTION	PRODUCT NUMBER
Universal Gauge, with Level, 17 in.	220336



## Transfemoral Length Gauge

US

### Product Features

- Measures in inches and metric



### Ordering information

**DESCRIPTION**

Transfemoral Length Gauge

**PRODUCT NUMBER****220137**

## Goniometer

US

### Product Features

- A combination level and adjustable protractor
- Useful when obtaining measurements that are relative to a horizontal plane



### Ordering information

**DESCRIPTION**

Goniometer

**PRODUCT NUMBER****51848**

## Casting Fixture Gauge

US

### Product Features

- For use with the Pelvic casting fixture



### Ordering information

**DESCRIPTION**

Casting Fixture Gauge

**PRODUCT NUMBER****220355**

# Rounded Blade Spatula

US



## Ordering information

DESCRIPTION	PRODUCT NUMBER
Rounded Blade Spatula 0.75 × 4 in. (19 x 102 mm) ,small	<b>220059</b>
Rounded Blade Spatula 1 × 6 in. (25 x 152 mm), large	<b>220063</b>

# Hot Mill Gloves

US

## Product Features

- Nitrile coated for grip and longer life
- Provides protection against heat up to 250°
- Flexible and strong
- One size fits all



## Ordering information

DESCRIPTION	PRODUCT NUMBER
Hot Mill Glove	<b>227008</b>



# Materials

## Specification symbols

.....  
**SE** Manufactured in Sweden

.....  
**US** Manufactured in USA  
.....

# Censoft

SE

## Specifications

Density: 200 kg/cubic meter

Shore: 00=74

## Product Features

- Excellent for use in soft sockets and insoles
- Made of EVA with a blend of 6% rubber
- Good compression memory
- Closed cell material that prevents moisture absorption
- Color: Beige
- Forming temperature: 266 - 320 °F (130 - 160° C)

## Ordering information

DESCRIPTION	TIME IN OVEN	PRODUCT NUMBER
35 x 51 x 0.12 in. (900 x 1300 x 3 mm)	1 - 2 min.	<b>637900003</b>
35 x 51 x 0.28 in. (900 x 1300 x 7 mm)	3 - 4 min.	<b>637900007</b>
35 x 51 x 0.55 in. (900 x 1300 x 14 mm)	6 - 8 min.	<b>637900014</b>



# Cenpol

SE

## Specifications

Density: 30 kg/cubic meter

Shore: 00=44

## Product Features

- Suitable for orthoses padding and the build-up of BK Cosmesis
- Made of EVA
- Closed cell material that prevents moisture absorption
- Color: beige
- Forming temperature: 266 - 320 °F (130 - 160° C)

## Ordering information

DESCRIPTION	TIME IN OVEN	PRODUCT NUMBER
39 x 39 x 0.12 in. (1000 x 1000 x 3 mm)	25 sec.	<b>637100003</b>
39 x 39 x 0.19 in. (1000 x 1000 x 5 mm)	30 sec.	<b>637100005</b>
39 x 39 x 0.39 in. (1000 x 1000 x 10 mm)	2 min.	<b>637100010</b>
39 x 39 x 0.59 in. (1000 x 1000 x 15 mm)	4 min.	<b>637100015</b>
39 x 39 x 0.78 in. (1000 x 1000 x 20 mm)	6 min.	<b>637100020</b>
39 x 39 x 1.0 in. (1000 x 1000 x 25 mm)	8 min.	<b>637100025</b>





# Thermo Foam 4E/ Firm Foam

US

SE

## Product Features

- Closed cell material that prevents moisture absorption
- Thermo foam: hardness shore 00 - 58
- Firm Foam: hardness shore 00 - 88 is considerably harder and suitable for the tongue on braces
- Forming temperature 300° - 356°F (150° - 180°C)
- Color: White



## Ordering information

### THERMOFOAM

DESCRIPTION	PRODUCT NUMBER
866 x 27.6 x 0.12 in. (22000 x 700 x 3 mm)	637700003
591 x 27.6 x 0.24 in. (15000 x 700 x 6 mm)	637700006
36 x 30 x 0.47 in. (920 x 770 x 12 mm)	637770012

### FIRMFOAM

DESCRIPTION	PRODUCT NUMBER
295 x 29.9 x 0.12 in. (7500 x 760 x 3 mm)	637760003
47 x 30 x 0.47 in. (1200 x 770 x 12 mm)	637770112

# Durrplex

US

## Product Features

- Ideal for check sockets, BK sockets, AK sockets and orthoses
- Skin friendly transparent thermoplastic that does not shrink
- Durable material that is flexible and easy to form to provide good attachment to the skin and seating comfort
- Forming temperature 300° - 356°F (150° - 180°C)



## Ordering information

DESCRIPTION	PRODUCT NUMBER
16 x 16 x 3/16 in. (400 x 400 x 4.7 mm)	168112
48 x 32 x 3/16 in. (1200 x 800 x 4.7 mm)	168125
16 x 16 x 1/4 in. (400 x 400 x 6 mm)	168187
48 x 32 x 1/4 in. (1200 x 800 x 6 mm)	168202
16 x 16 x 3/8 in. (400 x 400 x 9.5 mm)	168258
48 x 32 x 3/8 in. (1200 x 800 x 9.5 mm)	168270
16 x 16 x 1/2 in. (400 x 400 x 12 mm)	168312

# Polypropylene

SE

## Product Features

- Copolymer or homopolymer option
- Durable, easy to form thermoplastic
- Forming temperature 356° - 392°F (180° - 200°C)
- Color: Natural



## Ordering information

### COPOLYMER POLYPROPYLENE

DESCRIPTION	PRODUCT NUMBER
48 x 32 x 0.08 in. (1220 x 800 x 2 mm)	639122002
48 x 32 x 0.12 in. (1220 x 800 x 3 mm)	639122003
48 x 32 x 0.18 in. (1220 x 800 x 4.5 mm)	639122045
48 x 32 x 0.23 in. (1220 x 800 x 6 mm)	639122006
14 x 14 x 0.47 in. (350 x 350 x 12 mm)	639350012
14 x 14 x 0.59 in. (350 x 350 x 15 mm)	639350015
16 x 16 x 0.35 in. (400 x 400 x 9 mm)	639400009
16 x 16 x 0.47 in. (400 x 400 x 12 mm)	639400012
16 x 16 x 0.59 in. (400 x 400 x 15 mm)	639400015

### HOMOPOLYMER POLYPROPYLENE

DESCRIPTION	PRODUCT NUMBER
14 x 14 x 0.47 in. (350 x 350 x 12 mm)	639350112
14 x 14 x 0.59 in. (350 x 350 x 15 mm)	639350115
16 x 16 x 0.47 in. (400 x 400 x 12 mm)	639400112
16 x 16 x 0.59 in. (400 x 400 x 15 mm)	639400115



# Thermoflex

SE

## Product Features

- For flexible sockets and similar
- Skin friendly transparent thermoplastic that does not shrink
- Durable material that is flexible and easy to form to provide good attachment to the skin and seating comfort
- Forming temperature 300°- 356°F (150° - 180°C)



## Ordering information

DESCRIPTION	PRODUCT NUMBER
16 x 16 x 0.23 in. (400 x 400 x 6 mm)	637400006
47 x 32 x 0.23 in. (1200 x 800 x 6 mm)	637120006
16 x 16 x 0.31 in. (400 x 400 x 8 mm), Black	637400308
16 x 16 x 0.35 in. (400 x 400 x 9 mm)	637400009
47 x 32 x 0.35 in. (1200 x 800 x 9 mm)	637120009
16 x 16 x 0.39 in. (400 x 400 x 10 mm), Black	637400310
16 x 16 x 0.47 in. (400 x 400 x 12 mm)	637400012
47 x 32 x 0.47 in. (1200 x 800 x 12 mm)	637120012
16 x 16 x 0.47 in. (400 x 400 x 12 mm), Black	637400312

# Thermoflex with Silicone

SE

## Product Features

- For flexible sockets and similar
- Skin friendly thermoplastic that does not shrink
- Forming temperature 300°- 356°F (150° - 180°C)
- Durable material that is flexible and easy to form to provide good attachment to the skin and seating comfort
- Stays white at working condition
- Low friction



## Ordering information

DESCRIPTION	PRODUCT NUMBER
16 x 16 x 0.23 in. (400 x 400 x 6 mm)	637400206
47 x 32 x 0.23 in. (1200 x 800 x 6 mm)	637120206
16 x 16 x 0.35 in. (400 x 400 x 9 mm)	637400209
47 x 32 x 0.35 in. (1200 x 800 x 9 mm)	637120209
16 x 16 x 0.47 in. (400 x 400 x 12 mm)	637400212
47 x 32 x 0.47 in. (1200 x 800 x 12 mm)	637120212



# Cleani-Stump Antiseptic Wipe

SE

## Product Features

- Developed for use on the sensitive skin of residual limbs and can also be used to disinfect the inside of sockets
- Contains an effective alcohol and lactic acid antiseptic which reduce the amount of bacteria and some viruses on the skin for up to 16 hours
- In addition to the anti-bacterial ingredients found in Cleani-Stump, a special emollient has been added to smoothen and protect skin, helping to prevent breakdown in sensitive areas



## Ordering information

DESCRIPTION	PRODUCT NUMBER
Cleani-Stump Antiseptic Wipe case (case of 40 consumer boxes, 2000 total pieces)	<b>631020000</b>
Cleani-Stump Antiseptic Wipe (1 consumer box, 50 wipes pieces)	<b>631020001</b>

# Isolation Bags

SE

## Product Features

- The isolation bags is made of high quality natural latex rubber with a stretchability of 700%.



## Ordering information

DESCRIPTION	PRODUCT NUMBER
X-small, 1.9 x 6.3 in. (50 x 160 mm) 10 per package	<b>615100500</b>
Small, 3.1 x 10.6 in. (80 x 270 mm) 10 per package	<b>615100400</b>
Medium, 3.3 x 11 in. (85 x 280 mm) 10 per package	<b>615100300</b>
Large, 4.3 x 12.2 in. (110 x 310 mm) 10 per package	<b>615100200</b>
X-large, 4.9 x 13.8 in. (125 x 350 mm) 10 per package	<b>615100100</b>
XX-large, 5.5 x 15.7 in. (140 x 400 mm) 10 per package	<b>615100050</b>



# PVA Bags and Film

SE

## Product Features

- Prefabricated PVA bags made of polyvinyl alcohol film
- Manufactured with a narrow, consistent seam
- 20 pieces per box



## Ordering information

### PVA BAGS

DESCRIPTION	PRODUCT NUMBER
4 in. (102 x 10 x 5 cm)	631100004
6 in. (102 x 15 x 5 cm)	631100006
8 in. (102 x 20 x 5 cm)	631100008
10 in. (102 x 25 x 5 cm)	631100010
12 in. (102 x 30 x 5 cm)	631100012

### PVA FILM

DESCRIPTION	PRODUCT NUMBER
150 ft x 3.3 ft x 0.003 in. (45.7 m x 100 cm x 0.08 mm)	631100050

# Alginate Impression Powder

SE

## Product Features

- Ideal for casting hands, feet or reproducing sockets
- Easily dissolved in water



## Ordering information

DESCRIPTION	PRODUCT NUMBER
Box 13.2 lbs. (6 kg)	633110610
Plastic Bucket 4.4 lbs. (2 kg)	633110020

# PolyCar-C Sheets

US

## Product Features

- High performance reinforcing composite
- Easy to mold
- High carbon content
- Thermobonds to polypropylene, copolymer and metal

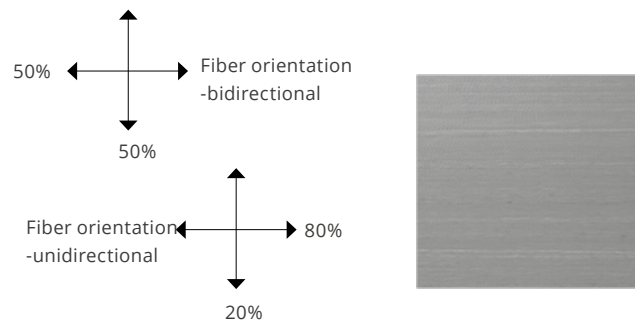

## Ordering information

DESCRIPTION	PRODUCT NUMBER
12 X 12 X 0.06 In. (300 X 300 X 1.5 Mm), Bidirectional Fiber Orientation	<b>076608</b>
12 X 24 X 0.06 In. (300 X 600 X 1.5 Mm), Bidirectional Fiber Orientation	<b>076610</b>
12 X 12 X 0.09 In. (300 X 300 X 2.3 Mm), Bidirectional Fiber Orientation	<b>076612</b>
12 X 24 X 0.09 In. (300 X 600 X 2.3 Mm), Bidirectional Fiber Orientation	<b>076614</b>
12 X 12 X 0.125 In. (300 X 300 X 3 Mm), Bidirectional Fiber Orientation	<b>076616</b>
12 X 24 X 0.125 In. (300 X 600 X 3 Mm), Bidirectional Fiber Orientation	<b>076618</b>
12 X 18 X 0.125 In. (300 X 450 X 3 Mm), Unidirectional Fiber Orientation	<b>076620</b>
12 X 36 X 0.125 In. (300 X 900 X 3 Mm), Unidirectional Fiber Orientation	<b>076622</b>

# Silicone

SE

## Ordering information

DESCRIPTION	PRODUCT NUMBER
Silicone Rubber A 1.25 Kg + B 0.13 kg	<b>632010125</b>
Silicone Oil 1.0 Kg	<b>632020010</b>
Stabilizer for Filler 0.1 Kg	<b>632030001</b>
Silicone Adhesive 90 MI	<b>632040090</b>
Color For Silicone Rubber 0.1 kg	<b>632050001</b>





# Transforming Silicone Putty

SE

## Product Features

- 1 kg - 500 g component A and 500 g component B
- Mixing ratio: 1:1
- Hardness shore A - 35



## Ordering information

DESCRIPTION	PRODUCT NUMBER
1 kg Transforming Silicone Putty (500 g component A and 500 g component B)	<b>632060010</b>

# Carbon Fiber Band

SE

## Product Features

- 55 yd. (50 m) per roll



## Ordering information

DESCRIPTION	WIDTH	PRODUCT NUMBER
Carbon Fiber Band	1.0 in. (25 mm)	<b>636125050</b>

# Polyester Stockinette - Lamination Tube

SE

## Product Features

- Made of 100% polyester
- Very strong and flexible, does not need to be combined with other materials to reach sufficient strength
- 22 yd. (20 m) per role



## Ordering information

DESCRIPTION	WIDTH	PRODUCT NUMBER
Lamination Tube	1.2 in. (30 mm)	<b>636203003</b>
Lamination Tube	2.4 in. (60 mm)	<b>636206005</b>
Lamination Tube	3.1 in. (80 mm)	<b>636208005</b>
Lamination Tube	3.9 in. (100 mm)	<b>636210010</b>

# Elastic Stockinette Tube, 12.5% Lycra

SE

## Product Features

- Made of 87,5% cotton and 12,5% lycra
- Excellent for casting patients
- 22 yd. (20 m) per role



## Ordering information

DESCRIPTION	WIDTH	PRODUCT NUMBER
Elastic Tube	1.6 in. (40 mm)	<b>636304020</b>
Elastic Tube	2.4 in. (60 mm)	<b>636306020</b>
Elastic Tube	3.1 in. (80 mm)	<b>636308020</b>
Elastic Tube	4.3 in. (110 mm)	<b>636311020</b>



## Elastic Stockinette Tube, 7% Lycra

SE

### Product Features

- Made of 93% cotton and 7% lycra
- Soft, with powerful compression
- Excellent for use under orthoses
- 22 yd. (20 m) per role



### Ordering information

DESCRIPTION	WIDTH	PRODUCT NUMBER
Elastic Stockinette	1.6 in. (40 mm)	<b>636404020</b>
Elastic Stockinette	2.4 in. (60 mm)	<b>636406020</b>
Elastic Stockinette	3.1 in. (80 mm)	<b>636408020</b>
Elastic Stockinette	4.3 in. (110 mm)	<b>636411020</b>

## Cotton Stockinette

SE

### Product Features

- Made of 100% cotton
- Excellent for use under orthosis, casting patients, or for donning prosthesis
- 22 yd. (20 m) per role



### Ordering information

DESCRIPTION	WIDTH	PRODUCT NUMBER
Cotton Stockinette	1.6 in. (40 mm)	<b>636504020</b>
Cotton Stockinette	2.4 in. (60 mm)	<b>636506020</b>
Cotton Stockinette	3.1 in. (80 mm)	<b>636508020</b>
Cotton Stockinette	4.3 in. (110 mm)	<b>636511020</b>

# Dacron Tape

US

## Product Features

- Durable tape has “web” type of construction to prevent stretching
- 25 yd. (22.5 m) per role
- Available in white, black and beige



## Ordering information

DESCRIPTION	WIDTH	PRODUCT NUMBER - WHITE	PRODUCT NUMBER - BEIGE	PRODUCT NUMBER - BLACK
Dacron Tape	0.5 in. (13 mm)	<b>212167</b>	<b>212242</b>	<b>212243</b>
Dacron Tape	0.75 in. (19 mm)	<b>212183</b>	<b>212252</b>	-
Dacron Tape	1 in. (25 mm)	<b>212209</b>	<b>212245</b>	<b>212246</b>
Dacron Tape	1.5 in. (38 mm)	<b>212225</b>	<b>212247</b>	<b>212248</b>
Dacron Tape	2 in. (51 mm)	<b>212241</b>	<b>212249</b>	<b>212250</b>

# Casting Socks

US

## Ordering information

Sold per dozen

DESCRIPTION	PRODUCT NUMBER
Casting Balloon, Large, 25 pack	<b>199076</b>
Casting Balloon, Medium, 25 pack	<b>199084</b>
Casting Balloon, Small, 10 pack	<b>199092</b>

# Comfort Casting Socks

US

## Ordering information

Sold in packages of 6

DESCRIPTION	PRODUCT NUMBER
Below Knee application	<b>63600006</b>





# Transfer Paper

US

## Product Features

- Different transfer papers available for different products

## Ordering information

DESCRIPTION	PRODUCT NUMBER
A. Butterflies	999101
B. Jungle animals	999102
C. Camouflage	999103
D. USA flag	999022
E. Planes, cars & trucks	999125
F. Leopard	999120
G. Solid blue	999021

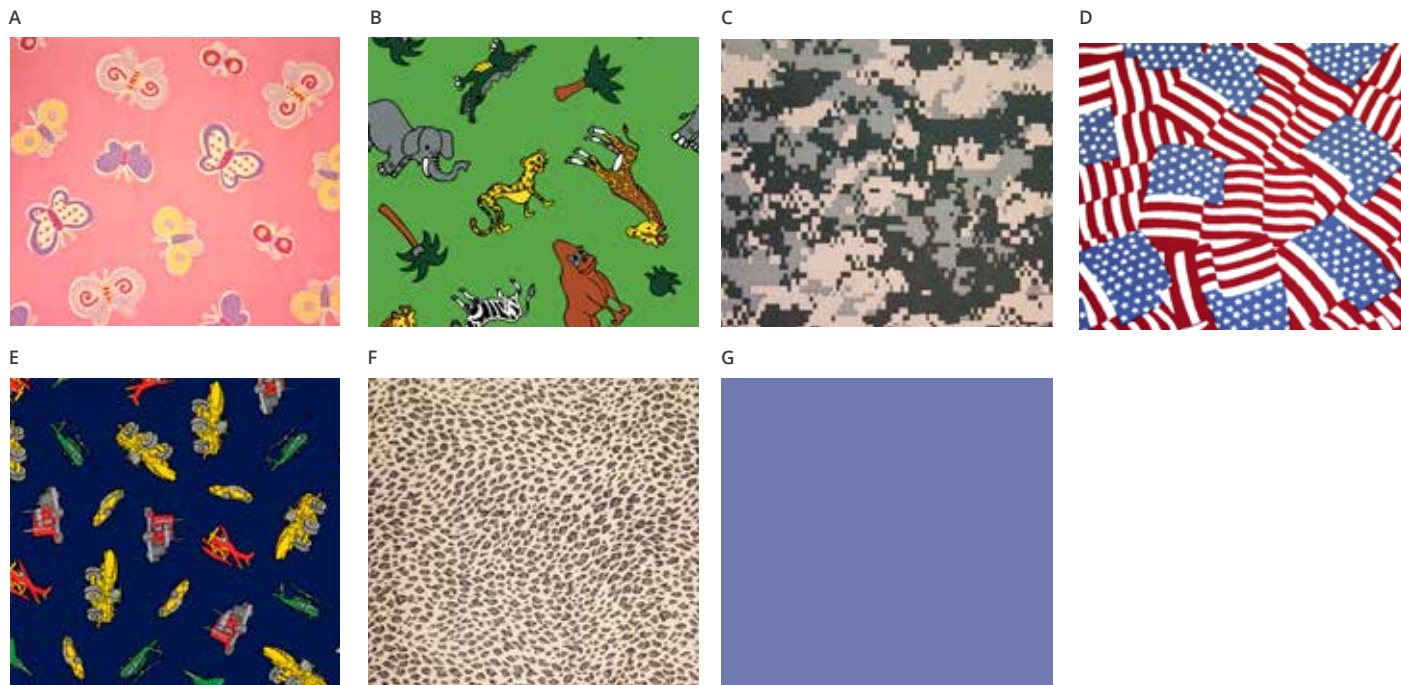



# Thermoformable Composite (TFC), Sheets

SE

## Product Features

- Unidirectional - Maximal strength in one direction and are good for bars, insoles and strengthening
- Bi-directional - The same strength from 0° and 90° direction and good for difficult shapes like the heel
- Sheet size: 39.4 x 23.6 in. (1000 x 600 mm)



## Ordering information

### COMFIL® THERMOFORMABLE COMPOSITE UNIDIRECTIONAL

DESCRIPTION	USAGE	THICKNESS	PRODUCT NUMBER
Unidirectional Carbon	Bars and other rigid parts	0.08 in. (2.0 mm)	<b>700010101</b>
Unidirectional Carbon & Glassfiber	Bars and rigid insole	0.1 in. (2.55 mm)	<b>700010103</b>
Unidirectional Carbon	Reinforcements	0.03 in. (0.7 mm)	<b>700010126</b>

### COMFIL® THERMOFORMABLE COMPOSITE BIDIRECTIONAL

DESCRIPTION	USAGE	THICKNESS	PRODUCT NUMBER
Bi-directional Glassfiber	Opening flaps	0.03 in. (0.9 mm)	<b>700010121</b>
Bi-directional Glassfiber	Flexible toe off parts	0.06 in. (1.5 mm)	<b>700010122</b>
Bi-directional Glass-and Carbonfiber	Rigid foot plates	0.06 in. (1.5 mm)	<b>700010123</b>
Bi-directional Carbonfiber	Difficult shapes and strengthening	0.03 in. (0.7 mm)	<b>700010124</b>
Bi-directional Glass-and Carbonfiber	Rigid foot plates	0.08 in. (2.1 mm)	<b>700010125</b>
Bi-directional Carbonfiber	Difficult shapes and strengthening	0.02 in. (0.5 mm)	<b>700010127</b>
Bi-directional Glassfiber, clear	Opening flaps	0.03 in. (0.7 mm)	<b>700010128</b>
Bi-directional LCP	Increased flexibility	0.02 in. (0.6 mm)	<b>700010135</b>

For information about the Thermoformable Composite material please contact Fillauer



# Thermoformable Composite (TFC), Insole

SE

## Product Features

- Flexible insoles are 0.06 in. (1.5 mm) thick and are better for shaping double curves, for example around the heel
- Rigid insole is 0.1 in. (2.5 mm) thick and made to be used as a rolling insole for diabetic patients
- Made for shaping single curves and is harder to shape around the heel
- Sold in pairs



## Ordering information

### COMFIL® INSOLE FLEXIBLE

	EUROPE	US	PRODUCT NUMBER
Size	35 - 37	3.5 - 5	<b>700030121</b>
Size	38 - 40	6 - 7.5	<b>700030122</b>
Size	41 - 43	8 - 9	<b>700030123</b>
Size	44 - 46	10.5 - 12	<b>700030124</b>

### COMFIL® INSOLE RIGID

	EUROPE	US	PRODUCT NUMBER
Size	35 - 37	3.5 - 5	<b>700030141</b>
Size	38 - 40	6 - 7.5	<b>700030142</b>
Size	41 - 43	8 - 9	<b>700030143</b>
Size	44 - 46	10.5 - 12	<b>700030144</b>

# Bars

SE

## Product Features

- We recommend 700020321 and 700020331 for AFO reinforcement
- We recommend 700040420 for matrix seating reinforcement
- Size 23.6 x 0.8 in. (600 x 20 mm)



## Ordering information

DESCRIPTION	THICKNESS	PRODUCT NUMBER
Unidirectional, Carbon & Glass Fiber	0.1 in. (2.55 mm)	<b>700020321</b>
Unidirectional, Carbon Fiber	0.06 in. (1.6 mm)	<b>700020331</b>
Unidirectional, Carbon Fiber	0.12 in. (3.2 mm)	<b>700040420</b>

# TFC Upright Bars & Silicone Forming Sleeve

US

## Product Features

- Stronger and lighter than conventional metal uprights
- Thermoformable contouring using heat gun or oven
- Accommodates smaller radii bends
- Increased stiffness and flexibility of carbon composite
- Will not corrode unlike conventional metal uprights
- Uses innovative post pre-preg carbon material
- Optimized attachment plates for conventional metal joints
- Half oval



## Ordering information

DESCRIPTION	SIZE	PRODUCT NUMBER
COMFIL® Composite Upright	3/4 x 18.5 in. (19 x 470 mm)	<b>700600</b>
Silicone Forming Sleeve	3/4 x 18.5 in. (19 x 470 mm)	<b>700610</b>
COMFIL® Composite Upright	5/8 x 18.2 in. (16 x 460 mm)	<b>700601</b>
Silicone Forming Sleeve	5/8 x 18.2 in. (16 x 460 mm)	<b>700611</b>
Flat Plate For TFC Upright 3/4 in. Bar		<b>700620</b>
Flat Plate For TFC Upright 5/8 in. Bar		<b>700621</b>
Flat Plate For TFC Upright 3/4 in. Bar Offset Joint		<b>700022</b>



# Cotton Stockinette

SE



## Product Features

- Good for air evacuation for vacuum
- 3.2 in wide, 22 yd. (20 m) per role

## Ordering information

DESCRIPTION	PRODUCT NUMBER
Cotton Stockinette	<b>636508020</b>

# Teflon Sheet

SE

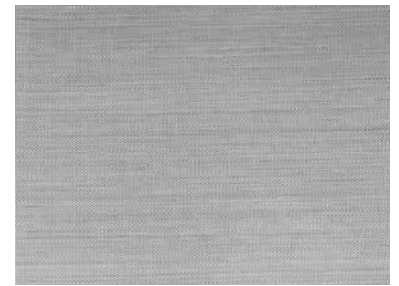

## Product Features

- Cover in the oven when heating material up
- Dimensions 40 x 40 x 0.01 in. (1000 x 1000 x 0.25 mm)

## Ordering information

DESCRIPTION	PRODUCT NUMBER
Teflon Sheet	<b>700000010</b>

# Silicone Sheet

US



## Ordering information

DESCRIPTION	SIZE	PRODUCT NUMBER
Silicone Sheet, Transparent, High Gloss	0.03 in. (0.8 mm)	600320

# Vacuum Bag material

SE



### Product Features

- Roll of 23 ft (10 m)
- Material: Nylon
- Thickness: 0,05 mm
- Width: 457 mm
- Maximum temperature: 246°C\*\*

\*\*: The maximum use temperature is dependent upon duration at maximum temperature and is process specific, we recommends testing prior to use.

## Ordering information

DESCRIPTION	SIZE	PRODUCT NUMBER
Vacuum Bag Material, Tube	18 x 0.002 in. (457 x 0.05 mm)	70000012

# Tape

SE



70000015



70000014

### Product Features

- High temp. tape for use with TFC material

## Ordering information

DESCRIPTION	USAGE	SIZE	PRODUCT NUMBER
Sealing Tape for Vacuum Bag	Sealing the vacuum bag	0.12 x 0.5in. x 24.9 ft. (3 x 12 mm x 7.6 m)	70000014
Tape	Fasten the release film to the plaster	1 in. x 108 ft (25 mm x 33 m)	70000015



## Silicone Glove

SE

### Product Features

- Sold individually
- Colors may vary



### Ordering information

DESCRIPTION	PRODUCT NUMBER
TFC Silicone Glove	700070010

## Release Film - sheet

SE

### Product Features

- Prevent moisture from reaching the carbon fiber
- Size 47.2 x 39.4 in. (1200 x 1000 mm)



### Ordering information

DESCRIPTION	THICKNESS	PRODUCT NUMBER
Release Film	0.001 in. (0.025 mm)	700000023

## Silicone Bag

SE

### Product Features

- For shiny surface



### Ordering information

DESCRIPTION	PRODUCT NUMBER
Silicone Bag, small	700000105
Silicone Bag, medium	700000107
Silicone Bag, large	700000109

# Index

Accessory Holder for Bench Carver	16	Elastic Stockinette Tube, 7% Lycra	71
Accessory Holder for Floor Carver	13	Elastic Stockinette Tube, 12.5% Lycra	70
Adjustable Mold Stand	40	Electronic Scale	60
Adjustable PVA Bag Pattern	59	Expansion Arbors	23
Air Attachment for Floor Carver	13	Fillauer Product Warranty	5
Alginate Impression Powder	67	Foot Switch for 115 V Carvers	14
Bar Contouring Device	45	Glassfiber Stockinette	69
Bars	76	Glove Donner	50
Bench Carver Floor Stand	16	Goniometer	58
Bending Irons	49	Grinding Rasps	25
Cable Swaging Tool	46	Heavy-Duty Retractable Utility Knife	53
Carbon Fiber Band	69	Hex Keys	52
Cast Cutter	55	Hex Screwdriver	52
Casting Fixture Gauge	58	Holding Frames	32
Casting Socks	72	Hot Mill Gloves	60
Cast Mandrels	56	Isolation Bags	66
Cast Spreaders	55	Joint Alignment Tool	48
Cenpol	62	Laminating Fixture LJ-100	43
Censoft	62	Lift Assist Kit for Floor Carver	14
Cleani-Stump Antiseptic Wipe	66	L-PET Stockinette	77
Comfort Casting Socks	72	Measuring Tapes	56
Contouring Fork and Bench Receptacle	48	Mobile Vacuum Unit	30
Contouring Irons	49	Original AP-ML Gauge	57
Cotton Stockinette	71	PDQ BT-1 Benchtop Infrared Oven	36
Cotton Stockinette	77	PDQ BT-4 Infrared Oven	37
Cutters & Replacement Blades	17	PDQ Bubble Forming Frame	39
Cutting Tool for 30 mm Tubes	54	PDQ Mold Library	40
Dacron Tape	72	PDQ Oven Fan Kit	39
Deburring Tool	54	PDQ Oven Gloves	41
Drape Forming Adapters	32	PDQ Plastic Rack	40
Drill Attachments 1/2"-13 Thread	17	PDQ PO-2 Infrared Oven	38
Drill Press Fixture	47	PDQ Rollabout Oven	35
Dual Purpose Expansion Arbors	24	Pipe Holding Fixtures	45
Durrplex	63	Pneumatic Cast Cutter	55
Dust Collection Hose Kit for 2100L	12	Pneumatic Sand Drum	19
Dust Collector for Bench Carver	16	PolyCar-C Sheets	68
Dust Collector for Floor Carver	12	Polyester Stockinette - Lamination Tube	70



Polypropylene	64	Torque Screwdriver	52
Portable Oilless Vacuum Pump	31	Torque Wrench	52
Prosthetic Bench Vise	46	Transfemoral Length Gauge	58
PVA Bags and Film	67	Transfer Paper	73
Release Film - sheet	79	Transforming Silicone Putty	69
Revolving Punch	51	Transtibial Length Gauge	57
Rivet Bar	49	Trautman Arbor 5001	7
Rounded Blade Spatula	59	Trautman Coneiak Polishing Arbors	27
Router Adapters	25	Trautman Double Drum Sander	8
Rubber Mixing Bowls	59	Trautman Single Speed Bench Carver	15
Rubber Sand Cones	21	Trautman Single Speed Floor Carver	10
Sand Drum	20	Trautman Tech Station	11
Scarpas Knife	53	Trautman Vacuum Stations	33
Scissors	51	Trautman Variable Speed Bench Carver	15
Scissors	80	Trautman Variable Speed Floor Carver	9
Shaft Foam Arbors	18	Tube Cutter	54
Silicone	68	Tycro Polishing Arbor	26
Silicone Bag	79	Universal Alignment Fixture	47
Silicone Glove	79	Universal AP-ML Gauge	57
Silicone Sheet	78	Urethane and Felt Arbors	19
Soft Foam Shaper	18	Vacuum Bag material	78
Spring Clamps	50	Vacuum Control Assembly	31
Stand	81	Vacuum Ejector	80
Stirrup Bender	48	Vacuum Pipe	81
Surform™ Files	56	Vacuum Stand	80
Surgical Scalpel	53	Vertical Fabricating Fixture, VFJ-100	44
Surgical Tubing	43	Vertical Fabrication Fixture, Universal	44
Tape	78	Water Reduction Filter	81
Tapered Felt Arbor/ Core	22	Yates Clamp	50
Teflon Sheet	77		
TFC Upright Bars & Silicone Forming Sleeve	76		
Thermoflex	65		
Thermoflex with Silicone	65		
Thermo Foam 4E/ Firm Foam	63		
Thermoformable Composite (TFC), Insole	75		
Thermoformable Composite (TFC), Sheets	74		
Tongue Tray	41		







